

getting to
grips with
**COLD WEATHER
OPERATIONS**



 **AIRBUS INDUSTRIE**

Flight Operations Support - Customer Services Directorate

Getting to grips with

**COLD WEATHER
OPERATIONS**

A Flight Operations View

FOREWORD

The purpose of this document is to provide Airbus operators with an understanding of Airbus aircraft operations in cold weather conditions, and address such aspects as aircraft contamination, performance on contaminated runways, fuel freezing limitations and altimeter corrections.

This brochure summarizes information contained in several Airbus Industrie documents and provides related recommendations.

At the end of each chapter, a summary of main information to be remembered is highlighted and grouped together in the overview chapter.

Should any deviation appear between the information provided in this brochure and that published in the applicable AFM, MMEL, FCOM, AMM, the latter shall prevail at all times

All readers are encouraged to submit their questions and suggestions, regarding this document, to the following address:

AIRBUS INDUSTRIE

Flight Operations Support
Customer Services Directorate
1, Rond Point Maurice Bellonte, BP 33
31707 BLAGNAC Cedex - FRANCE

TELEX: AIRBU 530526F
SITA: TLSBI7X
Telefax: 33 5 61 93 29 68 or 33 5 61 93 44 65



TABLE OF CONTENTS

Foreword

Overview

Useful information in Airbus Industrie documentation

Glossary / Definitions

Abbreviations

A. AIRCRAFT CONTAMINATION IN FLIGHT

A1 Icing principles

- A1.1 Atmospheric physics at a glance
- A1.2 Meteorology at a glance
- A1.3 Iced shapes accreted in flight
- A1.4 Other types of contamination

A2 Icing certification

- A2.1 Aerodynamics at a glance
- A2.2 The history of icing certification
- A2.3 Large jet icing certification

A3 In-flight ice protection

- A3.1 Ice protection means
 - A3.1.1 Hot bleed air
 - A3.1.2 Electrical heating
 - A3.1.3 Mechanical de-icing boots
- A3.2 Airbus procedures for flight in icing conditions
- A3.3 Ice detection
 - A3.3.1 General
 - A3.3.2 The Airbus Dual Advisory Ice Detection System (DAIDS)

B AIRCRAFT DE-ICING/ANTI ICING ON THE GROUND

B1 General

B2 De-/anti-icing awareness checklist - the basic requirements

B3 De-/anti-icing aircraft on the ground: «When, Why and How»

- B3.1 Communication
- B3.2 Conditions which cause aircraft icing
- B3.3 Checks to determine the need to de-/anti-ice
 - B3.3.1 The clean aircraft concept
 - B3.3.2 External inspection
 - B3.3.3 Clear ice phenomenon
 - B3.3.4 General checks
- B3.4 Responsibility: the de-/anti-icing decision
 - B3.4.1 Maintenance / ground crew decision
 - B3.4.2 Commander's decision

- B3.5 The procedures to de-ice/anti-ice an aircraft
 - B3.5.1 De-icing
 - B3.5.2 Anti-icing
 - B3.5.3 Limits and precautions
 - B3.5.4 Checks
 - B3.5.5 Flight crew information/communication
- B3.6 Pilot techniques
 - B3.6.1 Receiving the aircraft
 - B3.6.2 Cockpit preparation
 - B3.6.3 Taxiing
 - B3.6.4 Takeoff
 - B3.6.5 General remarks
- B4 Fluid characteristics and handling**
 - B4.1 De-icing/anti-icing fluids - characteristics
 - B4.1.1 Type I fluid characteristics
 - B4.1.2 Type II/IV fluid characteristics
 - B4.2 Fluid handling
 - B4.3 Environment and health
 - B4.4 De-icing/anti-icing equipment

C PERFORMANCE ON CONTAMINATED RUNWAYS

- C1 What is a contaminated runway?**
- C2 Aircraft braking means**
 - C2.1 Wheel brakes
 - C2.2 Ground spoilers
 - C2.3 Thrust reversers
- C3 Braking performance**
 - C3.1 Reduction of the friction coefficient μ
 - C3.1.1 Wet runway
 - C3.1.2 Fluid contaminated runway: Water, slush and loose snow
 - C3.1.3 Hard contaminated runway: Compacted snow and ice
 - C3.2 Precipitation drag
 - C3.3 Aquaplaning
 - C3.4 Correlation between reported μ and braking performance
 - C3.4.1 Information provided by airport authorities
 - C3.4.2 Difficulties in assessing the effective μ
 - C3.4.3 Data provided by Airbus Industrie
- C4 Aircraft directional control**
 - C4.1 Influence of slip ratio
 - C4.2 Influence of wheel yaw angle

C5 Crosswind

- C5.1 Demonstrated crosswind
- C5.2 Effect of runway contamination

C6 Performance optimization and determination

- C6.1 Performance optimization
 - C6.1.1 Flap setting
 - C6.1.2 Takeoff speeds
 - C6.1.3 Derated takeoff thrust
- C6.2 Performance determination

D FUEL FREEZING LIMITATIONS

D1 Introduction

D2 Different types of fuel

D3 Minimum allowed fuel temperature

- D3.1 Published minimum fuel temperature
- D3.2 A300/A310
- D3.3 A319/A320/A321
- D3.4 A330/A340

D4 Maximum acceptable fuel freezing point

- D4.1 Wish expressed for JET A1 freezing point relaxation
- D4.2 Fuel temperature encountered in flight

D5 Actual fuel freezing point

- D5.1 Fuel freezing point value
- D5.2 Mixing fuels

D6 Low temperature behavior of fuel

- D6.1 Pumpability limit
- D6.2 Protection against wax
 - D6.2.1 Heating the fuel
 - D6.2.2 Thermal insulation of tanks
 - D6.2.3 Stirring the fuel

E LOW TEMPERATURE EFFECT ON ALTIMETER INDICATION

E1 General

E2 Corrections

- E2.1 Low altitude temperature corrections
- E2.2 High altitude temperature corrections (En-Route)

E3 Takeoff charts

- E3.1 Acceleration altitude
- E3.2 Takeoff margins



OVERVIEW

A. AIRCRAFT CONTAMINATION IN FLIGHT

- **Atmospheric physics and meteorology** tell us that icing conditions generally occur from slightly positive °C down to -40 °C and are **most likely around FL100**. Nevertheless, it should be understood that if severe icing rarely occurs below -12 °C, **slightly positive OATs do not protect from icing and that icing conditions can be potentially met at any FL**.

High accretion rates are not systematically associated with Cumulonimbus; stratiform clouds can ice like hell!

- **Icing conditions** are far **most frequent than effective ice accretion**. Icing conditions do not systematically lead to ice accretion.
- Should the pilot encounter icing conditions in flight, some recommendations are:
 - In addition to using NAI and WAI according to procedures, the pilot should keep an eye on the icing process: Accretion rate, type of cloud.
 - When rapid icing is encountered in a stratiform cloud, a moderate change of altitude will significantly reduce the rate. It is an obligation for the ATC controller to accept altitude change.
 - If icing conditions prevail on the approach, keep speed as high as permitted, delay flap extension as much as possible, and do not retract flaps after landing.
- Ice and snow due to ground precipitation, or overnight stay, should be totally cleared before takeoff, regardless of the thickness. Otherwise aircraft is not certified for flying.
- Optional ice detector systems available on Airbus aircraft are advisory systems and do not replace AFM procedures. For the time being, Airbus Industrie is not convinced of the benefits of a primary ice detection system.

B. AIRCRAFT DE/ANTI ICING ON THE GROUND

- Aircraft contamination endangers takeoff safety and must be avoided. The aircraft must be cleaned.
- To ensure that takeoff is performed with a clean aircraft, an external inspection has to be carried-out, bearing in mind that such phenomenon as clear-ice cannot be visually detected. Strict procedures and checks apply. In addition, responsibilities in accepting the aircraft status are clearly defined.
- If the aircraft is not clean prior to takeoff it has to be de-iced. De-icing procedures ensure that all the contaminants are removed from aircraft surfaces.
- If the outside conditions may lead to an accumulation of precipitation before takeoff, the aircraft must be anti-iced. Anti-icing procedures provide protection against the accumulation of contaminants during a limited timeframe, referred to as holdover time.

- The most important aspect of anti-icing procedures is the associated holdover-time. This describes the protected time period. The holdover time depends on the weather conditions (precipitation and OAT) and the type of fluids used to anti-ice the aircraft.
- Different types of fluids are available (Type I, II, and IV). They differ by their chemical compounds, their viscosity (capacity to adhere to the aircraft skin) and their thickness (capacity to absorb higher quantities of contaminants) thus providing variable holdover times.
- Published tables should be used as guidance only, as many parameters may influence their efficiency - like severe weather conditions, high wind velocity, jet blast...- and considerably shorten the protection time.

C. PERFORMANCE ON CONTAMINATED RUNWAYS

AIRCRAFT BRAKING MEANS

- There are three ways of decelerating an aircraft:
The primary way is with the wheel brakes. Wheel brakes stopping performance depends on the load applied on the wheels and on the slip ratio. The efficiency of the brakes can be improved by increasing the load on the wheels and by maintaining the slip ratio at its optimum (anti-skid system).

Secondary, ground spoiler decelerates the aircraft by increasing the drag and, most importantly, improves the brake efficiency by adding load on the wheels.

Thirdly, thrust reversers decelerate the aircraft by creating a force opposite to the aircraft's motion regardless of the runway's condition. The use of thrust reversers is indispensable on contaminated runways.

BRAKING PERFORMANCE

- The presence of contaminants on the runway affects the performance by:
 1. A reduction of the friction forces (μ) between the tire and the runway surface,
 2. An additional drag due to contaminant spray impingement and contaminant displacement drag,
 3. Aquaplaning (hydroplaning) phenomenon.
- There is a clear distinction between the effect of fluid contaminants and hard contaminants:
 - Hard contaminants (compacted snow and ice) reduce the friction forces.
 - Fluid contaminants (water, slush, and loose snow) reduce the friction forces, create an additional drag and may lead to aquaplaning.

- To develop a model of the reduced μ according to the type of contaminant is a difficult issue. Until recently regulations stated that (wet and (cont can be derived from the μ observed on a dry runway ($\mu_{\text{dry}}/2$ for wet runway, $\mu_{\text{dry}}/4$ for water and slush).

Nevertheless, recent studies and tests have improved the model of μ for wet and contaminated runways, which are no longer derived from μ_{dry} . The certification of the most recent aircraft already incorporates these improvements.

CORRELATION BETWEEN REPORTED μ AND BRAKING PERFORMANCE

- Airports release a friction coefficient derived from a measuring vehicle. This friction coefficient is termed as “reported μ ”.
The actual friction coefficient, termed as “effective μ ” is the result of the interaction tire/runway and depends on the tire pressure, tire wear, aircraft speed, aircraft weight and anti-skid system efficiency.
To date, **there is no way to establish a clear correlation between the “reported μ ” and the “effective μ ”**. There is even a poor correlation between the “reported μ ” of the different measuring vehicles.

It is then very difficult to link the published performance on a contaminated runway to a “reported μ ” only.

- The presence of **fluid contaminants** (water, slush and loose snow) on the runway surface **reduces the friction coefficient**, may lead to **aquaplaning** (also called hydroplaning) and creates an **additional drag**.
This additional drag is due to the precipitation of the contaminant onto the landing gear and the airframe, and to the displacement of the fluid from the path of the tire. Consequently, braking and accelerating performance are affected. The impact on the accelerating performance leads to a limitation in the depth of the contaminant for takeoff.

Hard contaminants (compacted snow and ice) only affect the braking performance of the aircraft by a reduction of the **friction coefficient**.

- Airbus Industrie publishes the takeoff and landing performance according to the **type of contaminant**, and to the **depth** of fluid contaminants.

AIRCRAFT DIRECTIONAL CONTROL

- When the wheel is yawed, a side-friction force appears. The total friction force is then divided into the braking force (component opposite to the aircraft motion) and the cornering force (side-friction).
The maximum cornering force (i.e. directional control) is obtained when the braking force is nil, while a maximum braking force means no cornering.

- The sharing between cornering and braking is dependent on the slip ratio, that is, on the anti-skid system.
- Cornering capability is usually not a problem on a dry runway, nevertheless when the total friction force is significantly reduced by the presence of a contaminant on the runway, in crosswind conditions, the pilot may have to choose between braking or controlling the aircraft.

CROSSWIND

- Airbus Industrie provides a maximum demonstrated crosswind for dry and wet runways. This value is not a limitation. This shows the maximum crosswind obtained during the flight test campaign at which the aircraft was actually landed. Operators have to use this information in order to establish their own limitation.
- The maximum crosswind for automatic landing is a limitation.
- Airbus Industrie provides as well some recommendations concerning maximum crosswind for contaminated runways. These conservative values have been established from calculations and operational experience.

PERFORMANCE OPTIMIZATION AND DETERMINATION

- The presence of a contaminant on the runway leads to an increased accelerate-stop distance, as well as an increased accelerate-go distance (due to the precipitation drag). This results in a lower takeoff weight which can be significantly impacted when the runway is short.
- To minimize the loss, **flap setting and takeoff speeds should be optimized. Increasing the flap and slats extension results in better runway performance.** Both the accelerate-stop and accelerate-go distances are reduced. A short and contaminated runway naturally calls for a high flap setting. Nevertheless, one should bear in mind that the presence of an obstacle in the takeoff flight path could still require a lower flap setting as it provides better climb performance. **An optimum should be determined.** This optimum is usually found manually by a quick comparison of the different takeoff charts. The Airbus LPC (Less Paper in the Cockpit) enables an automatic computerized selection of the optimum flap.
- **The takeoff speeds**, namely V1, VR and V2 also **have a significant impact the takeoff performance.** High speeds generate good climb performance. The price to pay for obtaining high speeds is to spend a long time on the runway. Consequently, takeoff distances are increased and the runway performance is degraded. Thus, **a contaminated runway calls for lower speeds.** Once again, the presence of an obstacle may limit the speed reduction and **the right balance must be found.** Airbus performance programs, used to generate takeoff charts, take advantage of the so-called “speed optimization”. **The process will always provide the optimum speeds.** In a situation where the runway is contaminated, that means as low as possible.

- The **FLEXIBLE THRUST** principle, used to save engine life by reducing the thrust to the necessary amount, **is not allowed when the runway is contaminated**. Operators can take advantage of the **DERATED THRUST**. The main difference between Flex thrust and Derated thrust is that, in the case of flexible thrust, it is allowed to recover maximum thrust (TOGA), whereas it is not allowed to recover maximum thrust at low speeds in the case of derated thrust.
- Moreover, the reduction of thrust makes it easier to control the aircraft should an engine fail (lesser torque). In other words, any time an engine is derated, the associated VMC (Minimum Control Speed) is reduced. This VMC reduction allows even lower operating speeds (V1, VR and V2) and, consequently, shorter takeoff distances. **In a situation where the performance is VMC limited, derating the engines can lead to a higher takeoff weight.**
- Different methods are proposed by Airbus Industrie to determine the performance on a contaminated runway. The methods differ by their medium (paper or electronic) and the level of conservatism and details they provide.

D. FUEL FREEZING LIMITATIONS

- The minimum allowed fuel temperature may either be limited by:
 - The **fuel freezing point** to prevent fuel lines and filters from becoming blocked by waxy fuel (variable with the fuel being used) or
 - The **engine fuel heat management** system to prevent ice crystals, contained in the fuel, from blocking the fuel filter (fixed temperature). The latter is often outside the flight envelope and, thus, transparent to the pilot.
- Different fuel types having variable freezing points may be used as mentioned in the FCOM. When the actual freezing point of the fuel being used is unknown, the limitation is given by the minimum fuel specification values. In addition, a margin for the engine is sometimes required. The resulting limitation may be penalizing under certain temperature conditions especially when JET A is used (maximum freezing point -40°C). In such cases, **knowledge of the actual freezing point of the fuel being used generally provides a large operational benefit** as surveys have shown a significant give-away.
- Although the **fuel freezing limitation** should not be deliberately exceeded, it should be known that it **ensures a significant safety margin**.
- When mixing fuel types, operators should set their own rules with regard to the resulting freezing point, as it is not really possible to predict it. When a mixture of JET A/JETA1 contains less than 10% of JETA, considering the whole fuel as JETA1, with respect to the freezing point, is considered to be a pragmatic approach by Airbus Industrie when associated with recommended fuel transfer.

E. LOW TEMPERATURE EFFECT ON ALTIMETRY

- Temperature below ISA:
 - ➔ Aircraft **true altitude below indicated altitude**
- Very low temperature may:
 - ➔ Create a potential terrain hazard
 - ➔ Be the origin of an altitude/position error.
- Corrections have to be applied on the height above the elevation of the altimeter setting source by:
 - ➔ Increasing the height of the obstacles, or
 - ➔ Decreasing the aircraft indicated altitude/height.
- Minimum OAT should be established and specified for using approach and takeoff procedures if FINAL APPR mode (V-NAV in approach) use is intended.
- When OAT is below the minimum temperature indicated on a takeoff chart, the minimum acceleration height/altitude must be increased.

USEFUL INFORMATION IN AIRBUS INDUSTRIE DOCUMENTATION

- AMM Data - 12-31: AIRCRAFT PROTECTION
- FCOM Data

Aircraft Type	Chapter	Subject
A300 GE A300 PW A300 FF	8.03.14 8.02.11 2.02.09	PROCEDURES AND TECHNIQUES Inclement weather operations <ul style="list-style-type: none"> • Flight in severe turbulence • Operation in or near to heavy rain, hail or sleet • Operations in icing conditions • Operations from/to airports contaminated with loose/abrasive particles • Aircraft preparation for cold weather operation • Operation in windshear / downburst conditions • Windshield wipers and rain repellent • Ice accretion on upper wing surface • Operation from fluid contaminated runway (refer to Special Operations) • Crosswind • Temperature inversion at take-off
A310 A300-600	2.02.13	PROCEDURES AND TECHNIQUES Inclement weather operations <ul style="list-style-type: none"> • Flight in severe turbulence • Operation in or near to heavy rain, hail or sleet • Operations in icing conditions • Operations from/to airports contaminated with loose/abrasive particles • Aircraft preparation for cold weather operation • Operation in windshear / downburst conditions • Windshield wipers and rain repellent • Ice accretion on upper wing surface • Operation from fluid contaminated runway (refer to Special Operations) • Crosswind • Weather avoidance / optimum use of weather radar
A300 GE A300 PW A300 FF A310 A300-600	8.08.05 8.12.05 2.18.05 2.18.50	SPECIAL OPERATIONS Operations from fluid contaminated runway <ul style="list-style-type: none"> • Takeoff performance on wet and contaminated runways • Spray pattern, crosswind (refer to Procedure and Techniques), Taxiing, Takeoff, Landing, After landing and parking, Examples.
A320family A330/A340	3.04.30	SUPPLEMENTARY TECHNIQUES Ice and rain protection <ul style="list-style-type: none"> • Icing conditions • Operations in icing conditions • Rain repellent • Ground operations in heavy rain
A320family A330/A340	3.04.91	SUPPLEMENTARY TECHNIQUES Adverse weather <ul style="list-style-type: none"> • Severe turbulence • Operation in windshear or downburst conditions • Cold weather
A320 family A330/A340	2.04.10	SPECIAL OPERATIONS Fluid contaminated runway Takeoff performance on wet and contaminated runways Spray pattern, crosswind, Taxiing, Takeoff, Landing, Examples.



GLOSSARY / DEFINITIONS

Anti-icing is a precautionary procedure, which provides protection against the formation of frost or ice and the accumulation of snow on treated surfaces of the aircraft, for a limited period of time (holdover time).

Anti icing code describes the quality of the treatment the aircraft has received and provides information for determining the holdover time.

Aquaplaning or hydroplaning is a situation where the tires of the aircraft are, to a large extent, separated from the runway surface by a thin fluid film.

Braking action is a report on the conditions of the airport movement areas, providing pilots the quality or degree of braking that may be expected. Braking action is reported in terms of: good, medium to good, medium, medium to poor, poor, nil or unreliable.

Clear ice is a coating of ice, generally clear and smooth, but with some air pockets. It is formed on exposed objects at temperatures below, or slightly above, freezing temperature, with the freezing of super-cooled drizzle, droplets or raindrops. See also «cold soak».

Cold soak: Even in ambient temperature between -2°C and at least +15°C, ice or frost can form in the presence of visible moisture or high humidity if the aircraft structure remains at 0°C or below. Anytime precipitation falls on a cold-soaked aircraft, while on the ground, clear icing may occur. This is most likely to occur on aircraft with integral fuel tanks, after a long flight at high altitude. Clear ice is very difficult to visually detect and may break loose during or after takeoff. The following can have an effect on cold soaked wings: Temperature of fuel in fuel cells, type and location of fuel cells, length of time at high altitude flights, quantity of fuel in fuel cells, temperature of refueled fuel and time since refueling.

Contaminated runway: A runway is considered to be contaminated when more than 25% of the runway surface area (whether in isolated areas or not) within the required length and width being used is covered by the following:

- Surface water more than 3 mm (0.125 in) deep, or slush, or loose snow, equivalent to more than 3 mm (0.125 in) of water; or
- Snow which has been compressed into a solid mass which resists further compression and will hold together or break into lumps if picked up (compacted snow); or
- Ice, including wet ice

Damp runway: A runway is considered damp when the surface is not dry, but when the moisture on it does not give it a shiny appearance.

De-icing is a procedure by which frost, ice, slush or snow is removed from the aircraft in order to provide clean surfaces. This may be accomplished by mechanical methods, pneumatic methods, or the use of heated fluids.

De/Anti-icing is a combination of the two procedures, de-icing and anti-icing, performed in one or two steps.

A de-/anti-icing fluid, applied prior to the onset of freezing conditions, protects against the build up of frozen deposits for a certain period of time, depending on the fluid used and the intensity of precipitation. With continuing precipitation, holdover time will eventually run out and deposits will start to build up on exposed surfaces. However, the fluid film present will minimize the likelihood of these frozen deposits bonding to the structure, making subsequent de-icing much easier.

Dew point is the temperature at which water vapor starts to condense.

Dry runway: A dry runway is one which is neither wet nor contaminated, and includes those paved runways which have been specially prepared with grooves or porous pavement and maintained to retain «effectively dry» braking action, even when moisture is present.

Fluids (de-icing and anti-icing)

- De-icing fluids are:
 - a) Heated water
 - b) Newtonian fluid (ISO or SAE or AEA Type I in accordance with ISO 11075 specification)
 - c) Mixtures of water and Type I fluid
 - d) Non-Newtonian fluid (ISO or SAE or AEA Type II or IV in accordance with ISO 11078 specification)
 - e) Mixtures of water and Type II or IV fluid

De-icing fluid is normally applied heated to ensure maximum efficiency

- Anti-icing fluids are:
 - a) Newtonian fluid (ISO or SAE or AEA Type I in accordance with ISO 11075 specification)
 - b) Mixtures of water and Type I fluid
 - c) Non-Newtonian fluid (ISO or SAE or AEA Type II or IV in accordance with ISO 11078 specification)
 - d) Mixtures of water and Type II or IV fluid

Anti-icing fluid is normally applied unheated on clean aircraft surfaces.

Freezing conditions are conditions in which the outside air temperature is below +3°C (37.4F) and visible moisture in any form (such as fog with visibility below 1.5 km, rain, snow, sleet or ice crystals) or standing water, slush, ice or snow is present on the runway.

Freezing fog (Metar code: FZFG) is a suspension of numerous tiny supercooled water droplets which freeze upon impact with ground or other exposed objects, generally reducing the horizontal visibility at the earth's surface to less than 1 km (5/8 mile).

Freezing drizzle (Metar code: FZDZ) is a fairly uniform precipitation composed exclusively of fine drops - diameter less than 0.5 mm (0.02 inch) - very close together which freeze upon impact with the ground or other objects.

Freezing rain (Metar code: FZRA) is a precipitation of liquid water particles which freezes upon impact with the ground or other exposed objects, either in the form of drops of more than 0.5 mm (0.02 inch) diameter or smaller drops which, in contrast to drizzle, are widely separated.

Friction coefficient is the relationship between the friction force acting on the wheel and the normal force on the wheel. The normal force depends on the weight of the aircraft and the lift of the wings.

Frost is a deposit of ice crystals that form from ice-saturated air at temperatures below 0°C (32°F) by direct sublimation on the ground or other exposed objects. **Hoar frost** (a rough white deposit of crystalline appearance formed at temperatures below freezing point) usually occurs on exposed surfaces on a cold and cloudless night. It frequently melts after sunrise; if it does not, an approved de-icing fluid should be applied in sufficient quantities to remove the deposit. Generally, hoar frost cannot be cleared by brushing alone. **Thin hoar frost** is a uniform white deposit of fine crystalline texture, which is thin enough to distinguish surface features underneath, such as paint lines, markings, or lettering.

Glaze ice or rain ice is a smooth coating of clear ice formed when the temperature is below freezing and freezing rain contacts a solid surface. It can only be removed by de-icing fluid; hard or sharp tools should not be used to scrape or chip the ice off as this can result in damage to the aircraft.

Grooved runway: see dry runway.

Ground visibility: The visibility at an aerodrome, as reported by an accredited observer.

Hail (Metar code: GR) is a precipitation of small balls or pieces of ice, with a diameter ranging from 5 to 50 mm (0.2 to 2.0 inches), falling either separately or agglomerated.

Holdover time is the estimated time anti-icing fluid will prevent the formation of frost or ice and the accumulation of snow on the protected surfaces of an aircraft, under (average) weather conditions mentioned in the guidelines for holdover time. The ISO/SAE specification states that the start of the holdover time is from the beginning of the anti-icing treatment.

Ice Pellets (Metar code PE) is a precipitation of transparent (sleet or grains of ice) or translucent (small hail) pellets of ice, which are spherical or irregular, and which have a diameter of 5 mm (0.2 inch) or less. The pellets of ice usually bounce when hitting hard ground.

Icing conditions may be expected when the OAT (on the ground and for takeoff) or when TAT (in flight) is at or below 10°C, and there is visible moisture in the air (such as clouds, fog with low visibility of one mile or less, rain, snow, sleet, ice crystals) or standing water, slush, ice or snow is present on the taxiways or runways. (AFM definition)

Icy runway: A runway is considered icy when its friction coefficient is 0.05 or below.

Light freezing rain is a precipitation of liquid water particles which freezes upon impact with exposed objects, in the form of drops of more than 0.5 mm (0.02 inch) which, in contrast to drizzle, are widely separated. Measured intensity of liquid water particles are up to 2.5mm/hour (0.10 inch/hour) or 25 grams/dm²/hour with a maximum of 2.5 mm (0.10 inch) in 6 minutes.

Non-Newtonian fluids have characteristics that are dependent upon an applied force. In this instance it is the viscosity of Type II and IV fluids which reduces with increasing shear force. The viscosity of Newtonian fluids depends on temperature only.

NOTAM is notice containing information concerning the establishment, condition or change in any aeronautical facility, service, procedure or hazard, the timely knowledge of which is essential to personnel concerned with flight operations.

One step de-/anti-icing is carried out with an anti-icing fluid, typically heated. The fluid used to de-ice the aircraft remains on aircraft surfaces to provide limited anti-ice capability.

Precipitation: Liquid or frozen water that falls from clouds as rain, drizzle, snow, hail, or sleet.

Continuous: Intensity changes gradually, if at all.

Intermittent: Intensity changes gradually, if at all, but precipitation stops and starts at least once within the hour preceding the observation.

Precipitation intensity is an indication of the amount of precipitation falling at the time of observation. It is expressed as light, moderate or heavy. Each intensity is defined with respect to the type of precipitation occurring, based either on rate of fall for rain and ice pellets or visibility for snow and drizzle. The rate of fall criteria is based on time and does not accurately describe the intensity at the time of observation.

Rain (Metar code: RA) is a precipitation of liquid water particles either in the form of drops of more than 0.5 mm (0.02 inch) diameter or of smaller widely scattered drops.

Rime (a rough white covering of ice deposited from fog at temperature below freezing). As the fog usually consists of super-cooled water drops, which only solidify on contact with a solid object, rime may form only on the windward side or edges and not on the surfaces. It can generally be removed by brushing, but when surfaces, as well as edges, are covered it will be necessary to use an approved de-icing fluid.

Saturation is the maximum amount of water vapor allowable in the air. It is about 0.5 g/m³ at - 30°C and 5 g/m³ at 0°C for moderate altitudes.

Shear force is a force applied laterally on an anti-icing fluid. When applied to a Type II or IV fluid, the shear force will reduce the viscosity of the fluid; when the shear force is no longer applied, the anti-icing fluid should recover its viscosity. For instance, shear forces are applied whenever the fluid is pumped, forced through an orifice or when subjected to airflow. If excessive shear force is applied, the thickener system could be permanently degraded and the anti-icing fluid viscosity may not recover and may be at an unacceptable level.

SIGMET is an information issued by a meteorological watch office concerning the occurrence, or expected occurrence, of specified en-route weather phenomena which may affect the safety of aircraft operations.

Sleet is a precipitation in the form of a mixture of rain and snow. For operation in light sleet treat as light freezing rain.

Slush is water saturated with snow, which spatters when stepping firmly on it. It is encountered at temperature around 5° C.

Snow (Metar code SN): Precipitation of ice crystals, most of which are branched, star-shaped, or mixed with unbranched crystals. At temperatures higher than about -5°C (23°F), the crystals are generally agglomerated into snowflakes.

- **Dry snow:** Snow which can be blown if loose or, if compacted by hand, will fall apart upon release; specific gravity: up to but not including 0.35.
Dry snow is normally experienced when temperature is below freezing and can be brushed off easily from the aircraft.
- **Wet snow:** Snow which, if compacted by hand, will stick together and tend to or form a snowball. Specific gravity: 0.35 up to but not including 0.5.
Wet snow is normally experienced when temperature is above freezing and is more difficult to remove from the aircraft structure than dry snow being sufficiently wet to adhere.
- **Compacted snow:** Snow which has been compressed into a solid mass that resists further compression and will hold together or break up into chunks if picked up.
Specific gravity: 0.5 and over.

Snow grains (Metar code: SG) is a precipitation of very small white and opaque grains of ice. These grains are fairly flat or elongated. Their diameter is less than 1 mm (0.04 inch). When the grains hit hard ground, they do not bounce or shatter.

Snow pellets (Metar code: GS) is a precipitation of white and opaque grains of ice. These grains are spherical or sometimes conical. Their diameter is about 2 to 5 mm (0.1 to 0.2 inch). Grains are brittle, easily crushed; they bounce and break on hard ground.

Supercooled water droplets is a condition where water remains liquid at negative Celsius temperature. Supercooled drops and droplets are unstable and freeze upon impact.

Two step de-icing/anti-icing consists of two distinct steps. The first step (de-icing) is followed by the second step (anti-icing) as a separate fluid application. After de-icing a separate overspray of anti-icing fluid is applied to protect the relevant surfaces, thus providing maximum possible anti-ice capability.

Visibility: The ability, as determined by atmospheric conditions and expressed in units of distance, to see and identify prominent unlit objects by day and prominent lit objects by night.

Visible moisture: Fog, rain, snow, sleet, high humidity (condensation on surfaces), ice crystals or when taxiways and/or runways are contaminated by water, slush or snow.

Visual meteorological conditions: Meteorological conditions expressed in terms of visibility, distance from cloud, and ceiling, equal to or better than specified minima.

Wet runway: A runway is considered wet when the runway surface is covered with water, or equivalent, less than or equal to 3 mm or when there is sufficient moisture on the runway surface to cause it to appear reflective, but without significant areas of standing water.

ABBREVIATIONS

AAL	Above Aerodrome Level	CFDIU	Centralized Fault Data Interface Unit
AC	Advisory Circular	CFDS	Centralized Fault Data System
A/C	Aircraft	CFP	Computerized Flight Plan
ACARS	ARINC Communication Addressing and Reporting System	CG	Center of Gravity
AEA	Association of European Airlines	C/L	Check List
AFM	Airplane Flight Manual	cm	Centimeter
AGL	Above Ground Level	CMC	Centralized Maintenance Computer
AIP	Aeronautical Information Publication	CM1/2	Crew Member 1 (LH) / 2 (RH)
ALT	Altitude	CRT	Cathode Ray Tube
ALTN	Alternate	DA	Decision altitude
AMM	Aircraft Maintenance Manual	DBV	Diagonal Braked Vehicle
AMSL	Above Mean Sea Level	DFDR	Digital Flight Data Recorder
AoA	Angle of Attack	DET	Detection/Detector
AOC	Air Operator Certificate	DH	Decision Height
AOT	All Operators Telex	ECAM	Electronic Centralized Aircraft Monitoring
APU	Auxiliary Power Unit	ENG	Engine
ASD	Accelerate-Stop Distance	ETA	Estimated Time of Arrival
ASTM	American Society for Testing and Materials	ETD	Estimated Time of Departure
ATA	Aeronautical Transport Association	E/WD	Engine / Warning Display
ATC	Air Traffic Control	F	Fahrenheit
ATIS	Automatic Terminal Information Service	FAA	Federal Aviation Administration
ATS	Air Traffic Service	FAF	Final Approach Fix
AWO	All Weather Operations	FAR	Federal Aviation Regulations
C	Celsius, Centigrade	FBW	Fly By Wire
CAPT	Captain	FCOM	Flight Crew Operating Manual
CAS	Calibrated Airspeed	FL	Flight Level
CAT	Clear Air Turbulence	FLT	Flight
CAT I	Landing Category I (II or III)	FM	Flight Manual
CAVOC	Ceiling and Visibility OK	FMGS	Flight Management Guidance System
		FMS	Flight Management System
		F/O	First Officer

FOD	Foreign Object Damage
F-PLN	Flight Plan
ft	Foot (Feet)
FWC	Flight Warning Computer
GA	Go Around
GMT	Greenwich Mean Time
GPS	Global Positioning System
GPWS	Ground Proximity Warning System
GS	Ground Speed
G/S	Glide Slope
H	Hour
hPa	hecto Pascal
Hz	Hertz (cycles per second)
IAS	Indicated Air Speed
IATA	International Air Transport Association
ICAO	International Civil Aviation Organization
IFR	Instrument Flight Rules
ILS	Instrument Landing System
IMC	Instrumental Meteorological Conditions
in	inch(es)
INOP	Inoperative
ISA	International Standard Atmosphere
ISO	International Standard Organization
JAA	Joint Aviation Authorities
JAR	Joint Aviation Regulations
K	Kelvin
kg	kilogram
kHz	kilohertz
km	kilometer
kt	knot

lb	pounds (weight)
LDA	Landing Distance Available
LDG	Landing
LPC	Less Paper in the Cockpit
M	Mach
m	meter
MAPT	Missed Approach Point
MAX	Maximum
mb	Millibar
MDA/H	Minimum Descent Altitude / Height
MIN	Minimum
MLW	Maximum Landing weight
mm	Millimeter
MOCA	Minimum Obstruction Clearance Altitude
MORA	Minimum Off-Route Altitude
ms	Millisecond
MSA	Minimum Safe (or Sector) Altitude
MSL	Mean Sea Level
MTOW	Maximum Take Off Weight
NA	Not Applicable
NAI	Nacelle Anti Ice
NAV	Navigation
NIL	No Item Listed (Nothing)
NM	Nautical Miles
NOTAM	Notice To Airmen
OAT	Outside Air Temperature
OCA/H	Obstacle Clearance Altitude / Height
OM	Outer Marker
PANS	Procedures for Air Navigation Services
PAX	Passenger

PERF	Performance
PIREP	Pilot Report
PSI	Pounds per Square Inch
QFE	Actual atmosphere pressure at airport elevation.
QNE	Sea level standard atmosphere (1013 hPa or 29.92» Hg)
QNH	Actual atmosphere pressure at sea level based on local station pressure.
QRH	Quick Reference Handbook
RA	Radio Altitude/Radio Altimeter
REF	Reference
RTO	Rejected Take Off
RTOW	Regulatory Take Off Weight
RVR	Runway Visual Range
RWY	Runway
SAE	Society of Automotive Engineers
SAT	Static Air Temperature
SB	Service Bulletin
SFT	Saab Friction Tester
SID	Standard Instrument Departure
SOP	Standard Operating Procedures
STD	Standard
SYS	System
t	ton, tonne
T	Temperature
TAF	Terminal Aerodrome Forecast
TAS	True Air Speed
TAT	Total Air Temperature
TBC	To Be Confirmed
TBD	To Be Determined
TEMP	Temperature
T/O	Take-Off

TOD	Take-Off Distance
TOGA	Take-Off/Go-Around
TOGW	Take-Off Gross Weight
TOR	Take-off Run
TOW	Take-Off Weight
UTC	Coordinated Universal Time
V1	Critical engine failure speed
V2	T/O safety speed
VAPP	Final approach speed
VFR	Visual Flight Rules
VHF	Very High Frequency (30 - 300 MHz)
VLS	Lowest selectable speed
VMC	Minimum control speed
VMU	Minimum unstick speed
VOR	VHF Omnidirectional Range
VR	Rotation speed
VREF	Landing reference speed
VS	Stalling speed (=VS1g for Airbus FBW aircraft)
WAI	Wing Anti Ice
WPT	Waypoint
WX	Weather
WXR	Weather Radar
Z	Zulu time (UTC)
ZFW	Zero Fuel Weight



A. AIRCRAFT CONTAMINATION IN FLIGHT

The objective of this chapter is to explain some of the difficulties encountered by flight crews in winter time or cold/wet air. Many forms of ice may deposit or accrete on the airframe, in flight or on ground, and that will affect aircraft performance. It is difficult to determine how much the performance is affected. There are cases when the amount of ice looks benign and proves to produce large performance degradation. The opposite case may also be true.

However, thorough analysis of the incident/accident record strongly suggests that enhanced pilot awareness of icing is a key factor in dominating the icing threat.

A1 ICING PRINCIPLES

A1.1 Atmospheric physics at a glance

Water is a well-known component of atmospheric air. Clear air includes water vapor in very variable proportions according to air temperature (SAT or OAT). The maximum amount of water vapor allowable in the air is about 0.5 g/m³ at -30°C and 5 g/m³ at 0°C for moderate altitudes. These limiting conditions are called **saturation**.

Any amount of water in excess of the saturation conditions will show under the form of water drops or ice crystals. These form clouds.

Saturation conditions may be exceeded by two processes:

- First, is the **lifting of warm air**. Air lifting may be produced by meteorological instability or orography. Instability is associated with weather systems, perturbations or large amounts of clouds. Orographic effect is due to wind blowing onto a mountain, hence lifting on the exposed side.
- Second is the rapid cooling of the lower air layer during a **night with clear sky**.

In both of these conditions, the amount of water initially present in the air mass may become in excess of the saturation conditions at the new (lower) temperature. Excess water precipitates in the form of drops, droplets or ice crystals.

The icing phenomenon is due to the fact that water does not necessarily turn into ice just at, or below 0°C. Water at negative Celsius temperature may remain liquid; then, it is called **supercooled**. But supercooled drops and droplets are unstable. This means that they can freeze all of a sudden if they hit, or are hit by, an object, especially if the object is at negative temperature. That is the basic mechanism for aircraft icing.

Consequences of the above are the following:

- The range of OAT for icing is: slightly positive °C, down to -40°C; but severe icing rarely occurs below -12°C. This can be translated into altitudes: at mid latitudes, altitudes where severe icing is most likely to occur are around FL 100 down to the ground.

- Due to varying temperature conditions around the airframe, a slightly positive OAT does not protect from severe icing.
- Accumulation of ice (icing) occurs on the «penetrating» or protruding parts of the airframe: nose, wing or fin, or tailplane leading edges, engine intakes, antennas, hinges, etc.
- On ground, in addition to all types of precipitation (all types of snow, freezing rain), the full airframe may get covered with frost. That almost systematically occurs overnight, if the sky is clear and temperature gets around 0° C or below.
- Most of the time, icing conditions do not last for long in the sky. This is why it is unsafe to rely only on pilot reporting (PIREP or absence of PIREP) to detect icing conditions.

AI.2 Meteorology at a glance

Supercooled water can be found in many clouds in the atmosphere, provided the temperature is below and not too far from freezing. Largely convective clouds like big Cumulus or Cumulonimbus are good suppliers. Apart from the possible effects of hail, Cumulonimbus are a special icing threat, because, contrary to all other icing clouds, icing conditions can be met outside the cloud body, for example under the anvil. Anvils often generate freezing drizzle or freezing rain. The precipitation under an anvil can lead to severe icing. At tropical latitudes, this may happen at such high altitudes and outside air temperatures that no icing should normally be expected. But the good news is that it should not last for long. A good operational precaution would be to avoid flying under the root of the anvil when you turn around a Cumulonimbus.

Layers of stratiform clouds, **absolutely regardless of their thickness**, can exhibit high quantities of freezing drops, including freezing drizzle. That is because, in spite of their stratus appearance, they include some limited but continuous convective activity, which makes it an ideal location for generating freezing drizzle (have you met turbulence in a stratus? The answer must be: Sometimes, yes!).

Meteorology provides a classification of supercooled water drops according to their diameter in microns or drop size (one micron = 1 μm = one thousandth of a millimeter):

- 0 to 50 μm : standard supercooled droplets. They stay aloft and make clouds.
- 50 to 500 μm : freezing drizzle. They sink extremely slowly and generate curious ice shapes.
- 500 to 2000 μm : freezing rain. Fall down and lead to clear ice.

Cloud physics show that no cloud is ever made of a single drop size. One cloud can be unequivocally described by its spectrum of droplets. It is considered that most common supercooled clouds contain a spectrum of droplets between 0 and 50 μm , which culminates around 20 μm . When freezing drizzle is present, the spectrum is not deeply changed, but another peak, smaller, shows at about 200 μm , with very few drops in between. However, the large majority of the water content remains within the lower part of the spectrum (i.e. large droplets are much fewer than the 20 μm ones).



This situation is prone to icing. Low level stratus and other grey clouds may have a high water content.

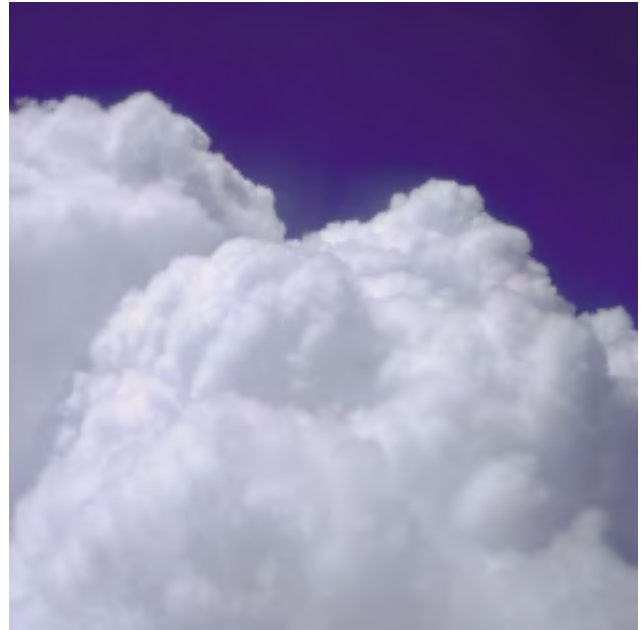

This type of cumulus congestus may hide severe intermittent icing.



Although the grey clouds contain supercooled liquid water, the situation is too windy to be a big icing threat except inside the cumulonimbus.



This type of thick stratus looking like heavy soup with a mountain blockage, may be a threat for icing.

Figure A1

AI.3 Ice shapes accreted in flight

In-flight icing experience shows a very large variety of ice accretion shapes and textures. Some are flat, some look like lace, some are like a hedgehog or a sea urchin. Others are single or double bumps, running along the leading edge, surprisingly pointing forward. But it is a hopeless task to try and relate the shapes with a given flying condition.

There is a very large number of parameters which may influence the icing process. A non-limiting list can be:

- Air temperature: OAT or SAT
- Aircraft speed or total air temperature: TAT
- Aircraft size
- Type of cloud
- Type of precipitation
- Liquid water content of the air mass
- Liquid water drop size distribution (see: certification)
- Possible presence of ice crystals
- Total water content of the air mass
- Aircraft skin local temperature and heat capacity
- Type and extent of the de-icing or anti-icing system.

The individual influence of each parameter noted above present a very difficult theoretical problem. The various influences are not at all additive. Shapes can range from a pure **moon arc** adhering on the leading edge, to a **double horn** (a nightmare for the aerodynamicist), or a flat, grooved plate, downstream of the leading edge itself (which is called **runback ice**), or even «shark teeth», pointing towards the airflow and randomly distributed aft of the leading edge. Moon arc is generally made of pure ice (called black ice or clear ice, as both mean the same!); double horn is often made of white, rough ice, called rime ice. At temperatures around 0 °C, rime ice is full of air bubbles and/or water flowing through.

The innumerable variety of ice shapes, particularly of those made of rime ice, reveals how complex the ice accretion process may be. Due to historical and technical reasons, a fully comprehensive study is virtually impossible.

For example, in reviewing the influence of flying speed: Speed has an effect on several characteristics of the ice which accretes. The best known effect is kinetic heating (KH). Kinetic heating is the difference between TAT and SAT. For example, at 250 kt, KH is about + 10°C. Those 10° show in a temperature increase of the leading edge relative to the rest of the airframe. KH is sometimes called temperature recovery, because it **naturally** heats the leading edge and therefore somewhat protects it from icing, as long as the outside air is above - 10°C.

The following graph gives an idea of the variety of shapes that could be encountered in a variety of clouds, which would offer icing conditions at all temperatures, from 0 °C down to -40 °C.

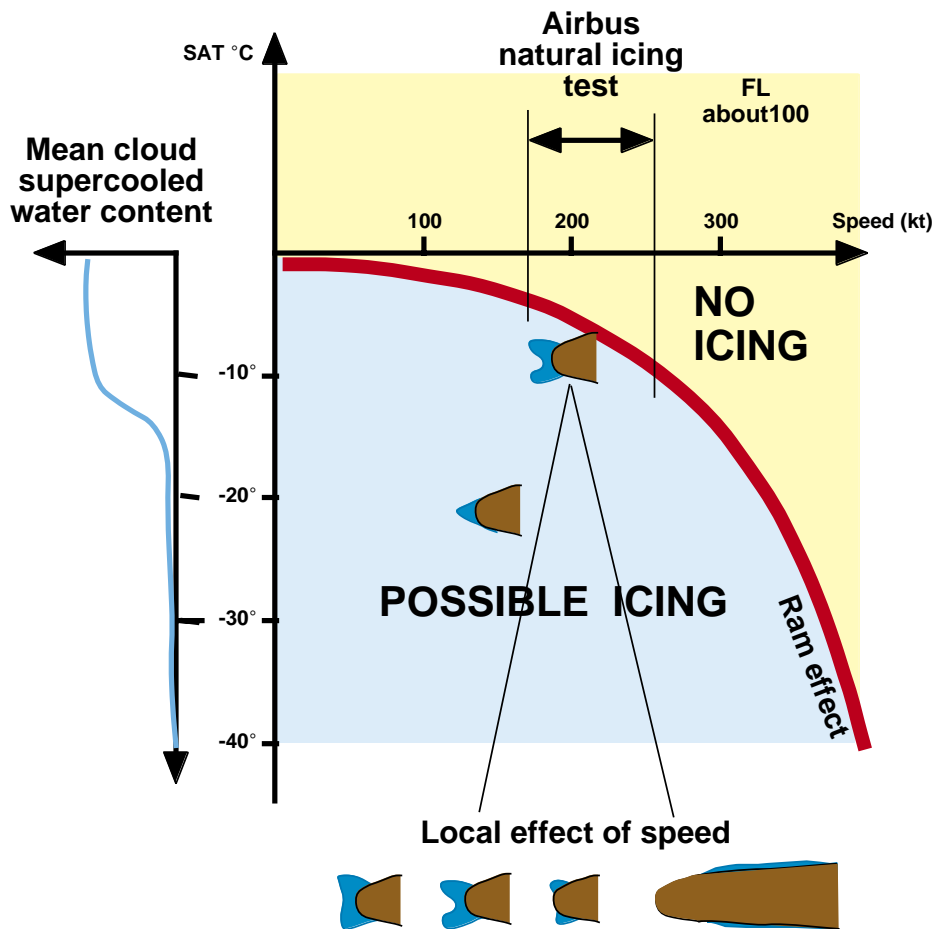

This figure shows:

1- the envelope of conditions, which are prone to icing, as a function of outside air temperature and aircraft speed. Only negative temperatures should be considered, but kinetic heating (KH, or ram effect) moves the maximum temperature for icing towards more negative values when speed is high. Limit is the red curve, based on the law of temperature recovery for altitudes around FL 100. However, conditions around the red curve may be those where the most difficult ice accretion cases can be met. Yellow sector is icing free. Blue sector is where icing may be encountered. Blue and yellow sectors are limited around -40°C, because practically no supercooled water might be present at colder temperatures.

2- the graph tends also to show how icing conditions may affect the ice accretion shape. Variability of shapes is great around the red curve, as shown by an example of speed effect around -10°C. In such a regime, shapes do vary very rapidly. In general, some runback ice accretion may be met just above the red curve at intermediate speeds. At lower temperatures, which means farther under the red curve, accretions are much whiter and tend to be of a pointed shape.

Figure A2

Observation of ice accreting in flight strongly suggests that the ice which effectively accretes is the **differential** result of **incoming supercooled water** (plus possible ice crystals) and outgoing amount of water due to a **mix of erosion, evaporation and sublimation**. The combined effect of those three is never negligible and, sometimes, one of them is so dominant in the overall icing process that no significant ice is accreting.

In that context, it is very difficult to describe, classify and predict ice shapes. Therefore, measures taken for aircraft protection against icing need to be based on some sort of definition of a «worst case» or an «envelope case» scenario. Such cases will be used in ice protection systems design and in certification.

Consequences of the above, include the following rules of thumb:

- Icing **conditions** are far more frequent than **effective** ice accretion for a given aircraft. It is not because icing has been reported ahead of you that your aircraft will also ice.
- Increase of speed decreases the amount of ice accreted.
- If rapid ice accretion is met, a moderate change of altitude is normally enough to decrease or stop the ice to accrete. The ATC controllers **must** immediately accept such a pilot request.

AI.4 - Other types of contamination

On ground, aircraft parked outside collect all types of precipitation which do not flow off: frost, condensation, freezing drizzle, freezing rain, slush, sleet, wet and dry snow. It would be useless to enumerate differences between those different cases. Very often, wings are covered with a mixture of different things. That, in itself, has two causes:

- Wing thermal characteristics vary, due to the possible presence of cold fuel and associated metal/composite structure.
- Normal weather evolution calls for precipitation, which vary against time due to temperature change. Snow often hides underneath ice, etc...

In all cases, a **wing must have been cleaned** prior to takeoff, regardless of the kind of contamination. ([See Chapter B - Aircraft De-icing / anti-icing on the ground](#))

To further complete the picture, taking off, landing and taxiing in slush may lead to projection of large amounts of wet snow which may freeze upon impact on sensitive parts of the airframe: flaps, slats and landing gear.

A2 ICING CERTIFICATION

A2.1 Aerodynamics at a glance

Aircraft designers do their best to ensure airframes have **smooth surfaces** to ease the surrounding airflow. This rule is applied with special care to the wing leading edge and upper surface, because smoothness in these areas produces the best **lift force**. Any type of ice accretion is an obstacle to smooth airflow. Any obstacle will slow the airflow down and introduce turbulence. That will degrade the lifting performance of the wing. Figure A3 gives the lift coefficient of a clean wing, and that of a wing spoiled by ice.

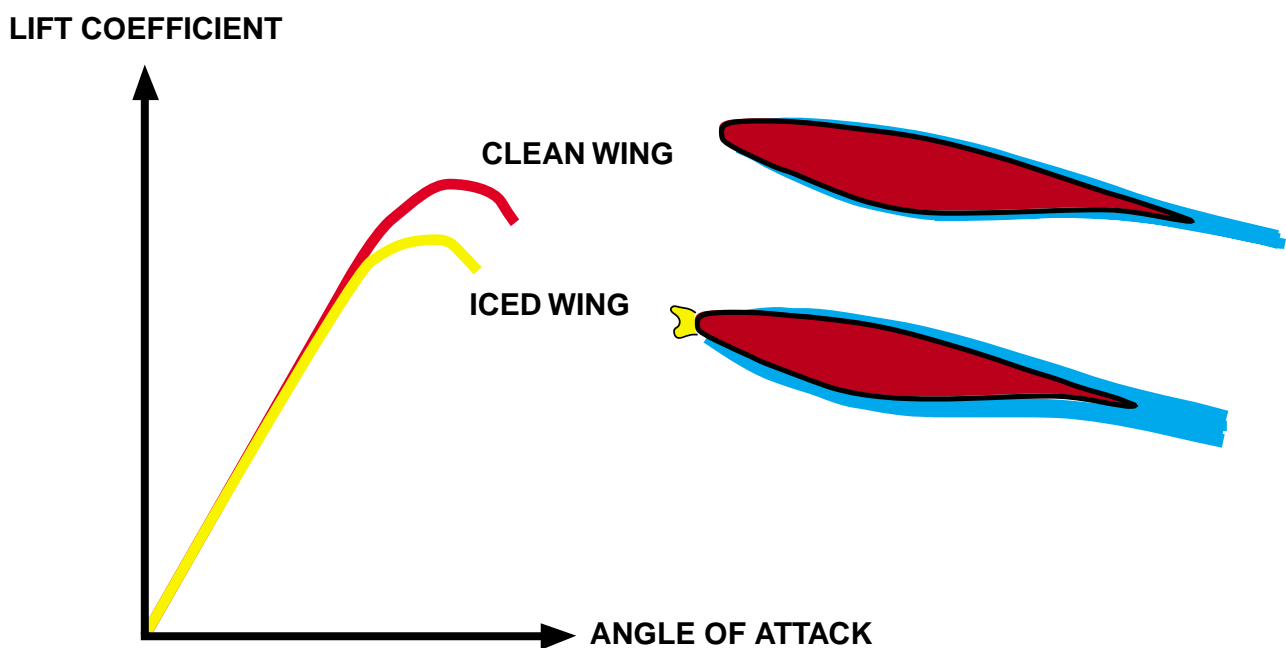
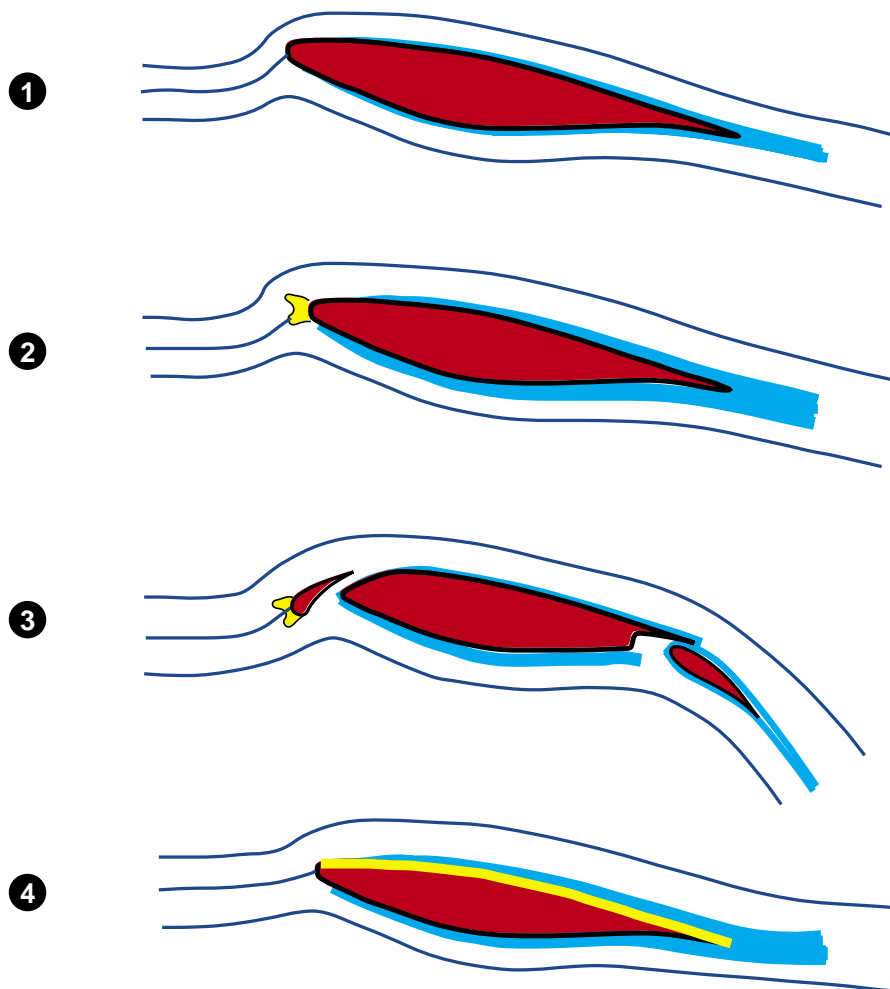

Figure A3

Both the maximum lift and the maximum achievable angle of attack have been decreased. The mechanism by which lift is affected has to do with the **evolution of the boundary layer** along the wing chord. [Figure A4](#) shows what happens at relatively high angle of attack.



This set of sketches gives comparative explanation of the impact of ice accretion and how these flight conditions are certified.

- Sketch #1 is a reference: clean wing with normal boundary layer
- Sketch #2 is an iced wing in configuration zero. The ice accretion on the leading edge is bigger than to scale. Aircraft is certified in those conditions because, although the boundary layer is thicker, the aerodynamic «circulation» around the wing is not severely affected. Lift is not highly affected, only flow separation, therefore stall, occurs at a little lower angle of attack. Aircraft minimum operational speeds take that maximum lift loss into account.
- Sketch #3 shows the same wing at landing conditions. In spite of the «pollution» of the slat, the slat slot restores a «normal» boundary layer on the wing box. Again, the «circulation» around the full wing is not severely affected and aircraft is certified to land in those conditions.
- Sketch #4 shows the result of morning frost after an overnight stay in clear sky conditions. Even a very thin layer of velvet ice will destroy the boundary layer all on the overwing. Result is a large decrease of «circulation». Lift loss may be large and is not predictable. This is why these conditions are not certified.

Figure A4

The boundary layer is **thicker** and more turbulent along the wing chord, and therefore, flow separation will occur at a lower angle of attack. Stall speed will be increased. Note how insidious that effect is, because at a moderate angle of attack, lift is about the same, as seen in [figure A3](#).

As it is not possible to take into account the whole possible variety of ice shapes, Airbus Industrie has defined procedures based on the worst possible ice shapes, as tested in flight with artificial ice shapes. As a consequence, in case of icing conditions, minimum speeds are defined allowing keeping adequate margins in terms of maneuverability relative to the actual stall with ice accretions. For example, when landing in configuration FULL with ice shapes, speed must be above VREF+5 kt. However, for the FBW system, the settings of the alpha protection system have been adjusted with ice shapes. **This means that the aircraft remains protected in case of ice accretions.** In turn, this means also that there is an increased margin relative to the stall in the normal clean wing status.

In the case of **ground icing**, a similar result will be reached because the boundary layer will **thicken** more rapidly along the chord. Earlier separation will occur, resulting in lower max angle of attack and max lift. As a relatively high angle of attack is normally reached during the takeoff rotation, it is easy to understand that wings **must be cleaned** prior to takeoff.

Even the very thin layer of velvet morning frost must be cleared. Thickness may be very small, but it covers 100% of the upperwing surface and the **rate of thickening** of the boundary layer along the wing chord is still considerable. That is a threat for takeoff, as nothing tells the pilot that he might not have the desirable lift for lift-off.

If the lower airframe structure has been extensively slushed during taxi time, it might be advisable not to takeoff. The slush would freeze in flight, and an incident on landing gear retraction might occur. Upon return to the gate, braking should be cautious and slats and flaps should not be retracted prior to cleaning.

This also applies to the tailplane. Ice deposits must be cleared off tailplane before takeoff to provide the expected rotation efficiency.

A2.2 The history of icing certification

In order to better understand today's status of icing certification, it is necessary to give a historical view of how the applicable rule was developed.

Icing became a problem on the dawn of air transportation. It also became a big concern for bombers during World War II. Then, statistical data on ice accretion and icing cloud characteristics was gathered. This remarkable piece of work gave birth to an icing database which is still very valid today. Given the variety of ice shapes encountered at the time, it was already clear that it would have been impossible to require flight testing of all

cases and to certify them individually. The idea of defining a «worst case» was born, together with a method of reaching «equivalent conditions».

The result was the well-known Appendix C to FAR 25, which defines the icing conditions to which an aircraft must be submitted prior to certification. Two types of ice accretion rates are required: One is called **maximum continuous**, the other is called **maximum intermittent**. They are supposed to cover stratiform and cumuliform clouds. Droplet diameter range is considered up to 50µm.

That rule and its interpretative material implicitly acknowledge the variety of ice shapes and requests aircraft to demonstrate that they can sustain **3 inches** of ice accretion (on unprotected parts). These 3 inches are a significant amount, derived from a 45-minute exposure. It was chosen to be an acceptable «worst case» or «envelope case». The flight conditions allowing to determine the location of the ice accretions on the leading edge profile have also been chosen as the worst ones, as they are closer to the wing upper surface than normal flying conditions would allow. It is clear that such a concept penalizes small aircraft more than large ones.

However, recent accident records show that it was insufficiently protective for commuter class aircraft and remained adequate, or even overprotective for large jets.

A number of commuter accident investigations proved that additive risks exist. These risks are associated with droplet diameters outside the FAR 25 Appendix C envelope, i.e. freezing drizzle from 50 to 500µm or freezing rain above. It is intended to extend the certification envelope. However, the accident investigations also show that improving pilot icing awareness would probably better increase the level of safety.

A2.3 Large jet icing certification

As stated above, large jets are less susceptible to icing problems than smaller ones, like commuters. Although the causes are not fully demonstrated, the following facts can be listed:

- **Faster flying speeds.** This is a very important factor, not only because of the ram effect, which cuts the icing risk at all OATs > -10°C. Atmospheric physics are such that, almost coincidentally, the statistical water content in supercooled droplets dramatically drops off between -10 and -15°C. Therefore, the potential for icing of faster aircraft is largely reduced.
- **3 inches** of ice accretion is widely accepted as resulting from a severe icing encounter and is taken as an envelope case. It is physically obvious that has less of an impact on large aircraft performance than on smaller ones.
- As previously stated, the mechanism by which ice deteriorates wing performance goes through deterioration of the **boundary layer**. Most large aircraft, and all Airbus aircraft have **slotted slats**, designed to generate a very good boundary layer over the main wing.

- In a given icing condition, a **leading edge of a larger radius** will pick up less ice than a smaller one.
- Large aircraft are **controlled by servo jacks**, which remove all hinge moment problems, known in icing on aircraft with mechanical gearing. FBW (Fly-By-Wire) systems further enhance that effect.
- Large aircraft generally have **thermal de-icing systems** that are fully evaporative.

The execution of an icing certification test in natural icing is difficult. Finding 3 inches of ice, a number of times, in the real atmosphere, regardless of the season, is an impossible challenge. Furthermore, after accreting such an ice, by the time the pilot exits the cloud and executes the certification maneuvers, most of the ice will be gone by combined effects of buffet during stalls, erosion, evaporation and sublimation. This is why natural ice shapes, once identified, are reproduced in **shapes of plastic foam** and glued to aircraft leading edges. Handling and performance tests are performed in that configuration.

Flight tests in natural icing are still done to demonstrate the efficiency of the de-icing systems, including failure cases. This is necessary because no plastic foam would ever reproduce the intense thermodynamic process which develops between the ice and the airframe.

As the certification method is overprotective for large jets, some reasonable assumptions have been made. One is very important and often unknown by pilots: Aircraft **are not certified for sustained icing in configurations with slats and flaps out**. Aircraft behavior was thoroughly checked with foam ice shapes, as picked up in the clean configuration. Then, as stated, slats and flaps were deflected and all reference speeds for take off and landing verified. It is assumed that an aircraft wouldn't stay long enough in icing conditions with slats/flaps extended to pick up such an amount of ice that performance would be modified.

The certification rule has proved to be more than adequate for large jets, as no accident or significant incident has ever occurred in the category due to in-flight icing. However, it should not be interpreted as a total protection against unlimited icing. Unlimited icing is totally unlikely to occur, but pilots must remain conscious that there is a limit somewhere, which could be given in terms of exposure time, coupled with ice accretion rate. Again, that limit has never proved to be encountered in 30 years of large jet transport.

A3 IN-FLIGHT ICE PROTECTION

A3.1 Ice Protection Means

There are three principle methods of protecting the airframe from ice accretion. Namely, mechanical, electrical heating or hot bleed air are used to de-ice and/or anti-ice the critical surfaces of the aircraft.

A3.1.1 Hot bleed air

Hot air is usually used on aircraft with jet engines. These systems are referred to as anti-ice systems, as they run continuously and are usually switched on before ice accretes. The heated surfaces thus prevent icing. Bleed air ice protection systems can also be used to remove light accumulations of ice. However, the amount of energy to evaporate accreted ice being very high, bleed air ice protection systems cannot be considered as fully effective de-icing systems.

All Airbus wing and nacelle (engine intake) ice protection systems use hot bleed air type anti-icing.

- **Wing leading edges:**

Such large aircraft as the Airbuses are significantly more icing resistant than smaller aircraft. This is due to the size and thickness of their wing. It was found that thick wings collect less ice than thin ones. That's why it was determined unnecessary to de-ice the full wingspan, to reach the iced wing performance shown on [figure A2](#). The de-iced part is heated so as to be evaporative, which means that the heat flux is so high as to melt the ice when it is accreting and the remaining water evaporates. Then, the heated part of the leading edge remains clean under icing conditions.

But that heat flux has a drawback. As it must keep the leading edges at highly positive temperature in flight, it needs to be computed so as to:

- First, compensate for outside air cooling (called forced convection),
- Second, melt the possible ice (compensate for the change of phase from ice to water).

The addition of both represents a high demand on the energy supply. That is the reason why it is inhibited on ground. In the absence of a rapid cooling due to airspeed, heat flux would damage the slats by overheating.

It should be noted that the tailplane and the fin also have leading edges that can pick up ice, but they are not de-iced. This is because it has been proven they both have large margins relative to their maximum needed efficiency. Tailplane maximum efficiency is needed in forward CG maneuvering and fin maximum efficiency is needed in single engine operation. Both are demonstrated to meet the certification targets with ice shapes.

- **Engine intake leading edges**

These are the most carefully de-iced, because the engine fan should be best protected. Hot air is bled from the engine compressor and heats the whole of the nacelle leading edge.

The standard procedures call for greater use of the nacelle anti-ice (NAI) than of the wing anti-ice system (WAI). This is due to a special feature of air intakes. In certain flight conditions, the temperature may drop by several degrees inside the intake («sucking» effect). Therefore, inside icing may occur at slightly positive outside air temperatures, whilst the wing itself wouldn't. The NAI is never inhibited, because the air is forced through at all speeds by the engine.

A3.1.2 Electrical heating

Electrical heating is typically used where small amounts of ice are encountered or on small surfaces like turboprop air intake. This method can be found on probes protruding into the airflow.

On Airbus aircraft sensors, static ports, pitot tubes, TAT and Angle of Attack (AoA) probes, flight compartment windows and waste-water drain masts are electrically anti-iced. For these items, the same problem of overheating exists as for the wing leading edge. It is solved automatically by air/ground logic, so that the pilot does not need to be concerned.

Electrical heating can also be found on turboprop aircraft to heat the inner part of the propeller blades. For the outer parts of the propeller, the centrifugal forces provide a so-called self-shedding effect, whereby any forming piece of ice is thrown away. On Airbus aircraft, the Ram Air Turbine (RAT) is driven by a two-blade propeller with a self-shedding design.

A3.1.3 Mechanical de-icing boots

They are typically used for propeller aircraft. The boots are rubber tubes, which are installed on the leading edges of the wing. As soon as ice accretes, the boots are inflated by pressurized air. The change of their shape breaks the ice layers. Mechanical boots ice protection systems are de-icing systems designed to remove already accreted ice. De-icing boots are not used on Airbus aircraft.

A3.2 Airbus procedures for flight in icing condition

The AFM/FCOM states that **icing conditions** may be expected when the OAT (on the ground and for takeoff) or when TAT (in flight) is at or below 10°C, and there is visible moisture in the air (such as clouds, fog with low visibility of one mile or less, rain, snow, sleet, ice crystals) or standing water, slush, ice or snow is present on the taxiways or runways.

These are conservative limits defined by airworthiness authorities to guide pilots in selecting anti-ice systems without necessarily guaranteeing that they will encounter icing conditions

The **engine ice protection system (Nacelle Anti-Ice: NAI)** must be immediately activated when encountering the above-noted icing condition. This procedure prevents any ice accretion (anti-icing) on the air intakes of the engines, thus protecting the fan blades from damage due to ingested ice plates (FOD). When the Static Air Temperature (SAT) is below -40°C the NAI must only be 'ON' when the aircraft enters cumulonimbus clouds, or when the Advisory Ice Detection System - if installed - annunciates ICE DETECTED ([refer to section A3.3](#)).

As stated above, the wings are more tolerant to ice accumulation.

The FCOM requires the activation of **Wing Anti-Ice System (WAI)** whenever there is an indication of airframe ice accumulation. The activation of the WAI system can be used to prevent any ice formation (anti-ice) or to remove an ice accumulation from the wing leading edges. Ice accumulation on the airframe can be evident either from an ice build-up on the windshield wipers or on the ice detector pin (visual cue), located between the two front windshields.

If a Dual Advisory Ice Detection System is installed ([see section A3.3](#)), the WAI system must be activated, when SEVERE ICE DETECTED is annunciated through a dedicated warning. It should be noted that detection through the ice detection system may appear later than actual ice accretion on the wipers, due to the fact that the wipers in certain conditions are more sensitive to ice build-up. The detectors have been calibrated during extensive flight and wind tunnel testing, so that the severe ice warning corresponds to an amount of ice on the leading edge, which is not critical for the aircraft's aerodynamic performance or handling qualities. However, the ice detection system being **advisory**, the flight crew must not wait for the severe ice detection signal to appear, but should activate WAI according to the FCOM.

The AFM recommends avoiding extended flight in icing conditions with extended slats and flaps, as accreted ice may block the retraction of the high lift devices causing mechanical damage to the slat / flap system.

If the pilot suspects that ice is accumulating on the protected surfaces (WAI inoperative), or if the pilot suspects that a significant amount of ice is accumulating on the unprotected parts of the wing, VLS must be increased as specified in the AFM/FCOM.

In all cases the decision to activate and de-activate the Nacelle and Wing Anti-ice systems is in the responsibility of the flight crew, based on the above FCOM criteria.

A3.3 Ice Detection

A3.3.1 General

The definition of icing conditions, as «visible moisture and less than 10°C TAT» has proven to be rather conservative. As already stated, when icing conditions are present (as per the definition), it does not necessarily mean that ice accretes on the aircraft. On the other hand, there are situations where the icing conditions, as per the AFM, are difficult for the flight crew to identify, e.g. during flight at night-time.

Although at night it is possible to check visibility with the headlights on, or to estimate the visible length of the wing, visibility depends only on the size of the particles, not on the encountered liquid water content, which is important for ice accretion. For instance, big ice crystals do not harm the wing but they reduce visibility more than water droplets. Over the past years, a large number of ice detection technologies have been successfully developed to enable the identification of ice accretion on the airframe and/or the presence of icing conditions. Generally, these technologies enable:

- A decreased crew workload,
- Increased safety for ground or flight operations in icing conditions,
- Fuel saving.

The following paragraph provides a brief overview of the ice detection principles that are most commonly used in service:

(a) Visual cue:

The pilot is provided with visual cues (specific or not specific) to decipher the icing conditions that are encountered.

The following information can be extracted from these cues:

- Beginning of ice accretion;
- Type of icing encountered (rime, glaze and mixed);
- Ice thickness;
- Accretion rate;
- End of ice accretion, if the cue is periodically de-iced.

Potential use:

- To determine the icing conditions, in order to apply the AFM/FCOM procedures (for activating the various ice protection systems),
- Last element to be free of ice, indicating the end of the specific icing procedures, if any,
- To detect particular icing conditions (supercooled large droplets, or ground icing).

(b) Detection of icing conditions:

The detector is intended to detect icing conditions in flight and to provide crew indication or to automatically actuate the system whenever the aircraft is flying in icing conditions that accrete more than a specified thickness. These detectors are generally intrusive to the airflow.

The following are the most common types of intrusive detectors which have been or are currently being used:

- Vibrating finger (piezoelectric, magnetostrictive or inductive transducers) with measurement of the resonant frequency variation. This technology, known as Rosemount (now BFGoodrich) detector, is today the most widely used for aircraft ice detection systems, including the Airbus Dual Advisory Ice Detection System.
- Vibrating surface (through piezoelectric transducers) fitted on a finger end, with measurement of the stiffness variation of a membrane. Such a system developed by Vibrometer is being certified on Dash 8-400.

It should be noted that the above technologies do not identify icing conditions in the meteorological sense, they only detect icing conditions indirectly. Whereas the detectors can provide a signal homogenous with an accretion rate, based upon their sensitivity, they do not reflect how much ice is collecting on the aircraft's critical surfaces. The detectors are mounted on the airframe, at a location, which is the most sensitive to ice accretion, i.e. the location where ice is first encountered. The correlation between ice accumulation at this sensitive location and ice accretion (and accretion rate) on critical aircraft surfaces (e.g. the engines inlets and the slats), are tested and validated in extensive flight and wind tunnel testing.

(c) Detection of ice accretion:

The detectors are intended to detect any type of ice which forms on a specific surface, such as leading edge of wings or the air intake and the wing upper surfaces. They are operative for in-flight or on ground icing and provide crew indication or automatically actuate the system whenever the aircraft is within icing conditions that accrete more than a specified thickness. These detectors are generally non-intrusive (flush-mounted). They are integrated and detect ice formation over their sensing surfaces. Some of them are able to measure the ice layer thickness, or to distinguish ice from other contaminants (water, slush, de/anti icing fluids, etc). Most of these detectors provide a limited sensing surface, which does not necessarily reflect the status of the whole surface to be monitored.

There are several types of ice detection systems, depending on their technologies, their uses and their level of integrity /reliability. Usually, the following definitions are employed:

● **Ice detector**

An ice detector is generally designed to provide a signal when the aircraft is operating in icing conditions either in flight or on the ground at static. For in-flight application, the ice detector signal is used for ice protection system activation and the respect of AFM icing procedure.

● **Advisory system**

The detector sends an informational advisory signal to the pilot. The pilot still has the responsibility to detect the icing conditions, or the presence of ice (or other contaminants such as snow, slush...) and to take the appropriate action, as required by the AFM/FCOM. There are no safety objectives linked to the detection system.

● **Primary system**

The detector sends a signal, reliable enough to be used as a primary information to warn the pilot. The consequences of an undetected system failure must be established in order to design a robust system architecture.

● **Automatic system**

The ice detection system automatically activates or deactivates the ice protection system, according to the status of the icing conditions it senses. Status (detection/no detection,

protection system activated/not activated and failures) is provided to the crew for information.

Note 1: A primary ice detection system can either have manual actuation (by the crew) or automatic actuation of the ice protection systems.

Note 2: An automatic system should be designed as a primary system.

- **Intrusive detector**

The detector protrudes into the aerodynamic flow. The detector, or its sensitive part, is impinged by the water droplets. These detectors generally sense ice information on their sensitive parts or measure the icing conditions' characteristics.

- **Non intrusive detector**

The detector is flush-mounted with the aerodynamic surface. It senses the ice formation or deposit on its sensitive parts, or makes an analysis of the atmosphere characteristics at a distance.

Ice detection systems assist the pilot in operating in icing conditions. They also have the potential of fuel saving, due to the optimization of hot bleed air for NAI/WAI activation. This can be deduced from the fact that, when an ice detection system is used, the ice protection system is only activated when icing conditions are really encountered. When following the conservative AFM procedures, the ice protection system may be activated when no real icing occurs. Statistical studies have shown that the AFM-defined icing conditions may lead to up to 80% of «unnecessary» activation of the ice protection systems.

A3.3.2 The Airbus Dual Advisory Ice Detection System (DAIDS)

The Dual Advisory Ice Detection System is intended to support the pilot in identifying outside meteorological conditions which might lead to ice accumulations on the airframe. In this sense, the meaning of icing conditions is less conservative and more precise than AFM definition, because the icing condition detected by the DAIDS is based on real ice build-up measured by the probes. The location of the DAIDS has been chosen such that two ice detection thresholds can be provided indicating the severity of the icing conditions and allowing the separate activation of the wing and nacelle anti-ice systems.

The operation of the DAIDS can be summarized as follows:

- The flight crew activates and de-activates the Engine and Wing Anti-Ice Systems based on the AFM procedure (TAT < 10 °C and visible moisture).
- The ice detection signal provides the flight crew with an additional indication of icing.
The AFM procedures are not replaced
- The system is operational in flight only (Altitude >= 1500 ft and TAT < 8°C).
- Two warning levels are provided:
 - The ICE DETECTED message is generated to activate the engine anti-ice system.
 - The SEVERE ICE DETECTED message is generated to activate the wing anti-ice system.
- When icing conditions are no longer detected, the system reminds the crew that the anti-ice systems are still selected ON.

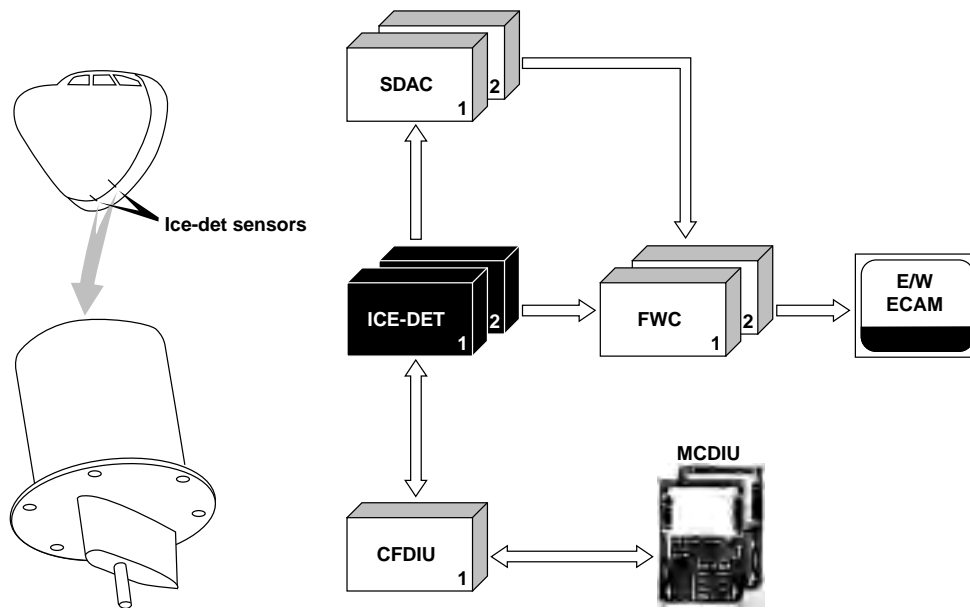

Figure A5 - Dual Advisory Ice Detection System Architecture

The principle procedures relating to the DAIDS are summarized in the table shown below.

	Event	FWC		Panel Indication	Crew Action
		ECAM Engine /Warning display (WARNING/MEMO)	CAUTION	NAI/WAI	
Normal	Ice detected	<u>ICE DETECTED</u>	MASTER + 🔔		Switch on NAI according to FCOM procedure
	Severe ice detected	<u>SEVERE ICE DETECTED</u>	MASTER + 🔔		Switch on WAI / NAI according to FCOM procedure
	No ice detected and NAI/WAI «ON»	ENG A.ICE / WING A.ICE (pulsing)	Nil	ON	Switch on WAI / NAI according to FCOM procedure
Failure	Probe Failure	<u>ICE DET FAULT</u>	MASTER + 🔔		FCOM procedure
	NAI / WAI valve / control failure	<u>NAI / WAI FAULT</u> message depending on the failure case	MASTER + 🔔	FAULT	FCOM procedure

🔔 means Single Chime aural warning

Figure A6 - DAIDS procedures

Ice detectors

Currently all A330/A340 aircraft - for the A320 family it is optional - are equipped with an ice detector pair, manufactured by Rosemount Aerospace (now BFGoodrich). These detectors form the essential part of the Dual Advisory Ice Detection System. The detectors are designed to measure ice accretion on the sensor probes.

The two ice probe type detectors are symmetrically installed in the front fuselage section, about 30 cm in front of the nose landing gear bay. Each sensor is mounted into a hole of approximately 80 mm in diameter, with 6 flush fasteners. The detector itself has an airfoil-shaped part standing out into the airflow for about 40 mm, with an additional cylindrical probe of 25,4 mm length and 6,35 mm in diameter. The airfoil makes it possible for the probe to perpendicularly stick out into the airflow beyond the boundary. The probes are also provided with a heating device to de-ice the probe. This is used to determine the severity of icing. The sensor can detect the presence of icing conditions and also approximate their ending.

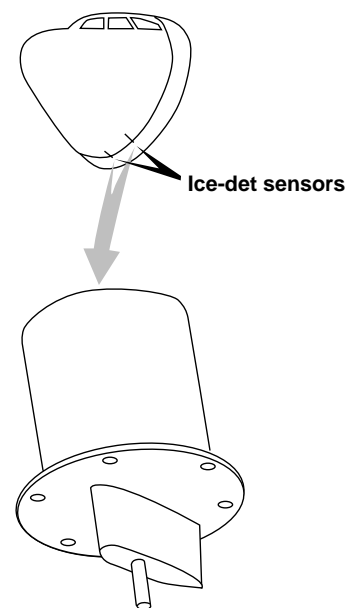

Figure A7 - Ice Detector Location

Magnetostriction: The ferro-magnetic material changes dimension under the influence of a magnetic field

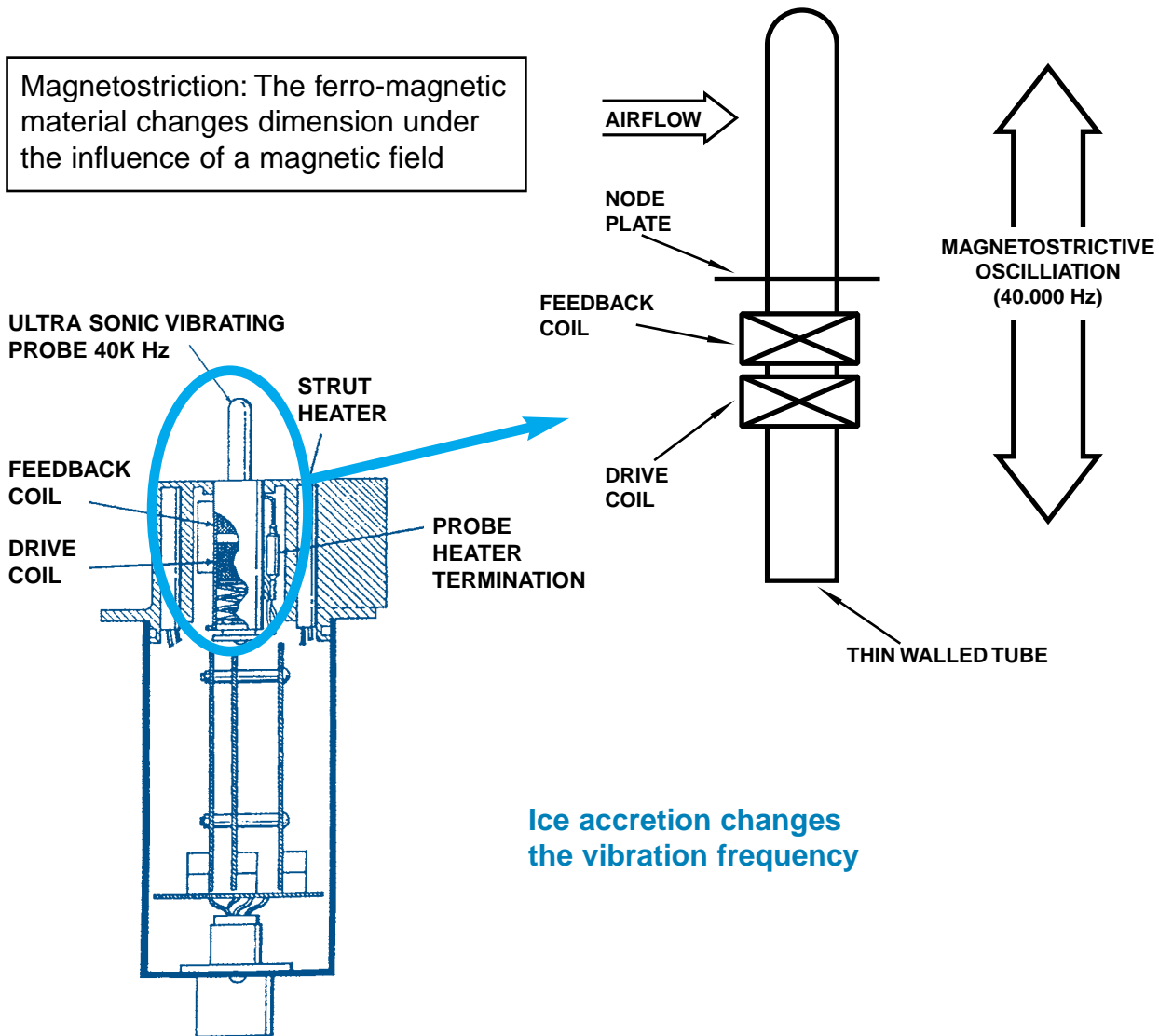

Figure A8 - Ice Detection Principle

Ice Detection Principle

The cylindrical probe, a tube of a nickel alloy, is oscillating axially driven by magnetostrictive (*) forces with a frequency of approximately 40 kHz. This is the resonant frequency of the probe, which is measured as the system feedback. If there is ice accreted to the tube, the mass of the probe is changed and therefore its resonant frequency decreases. After heating the probe, a new ice accretion is possible.

(*) Some ferromagnetic materials change their dimensions under the influence of a fluctuating magnetic field; this is called magnetostrictive.

Signal Processing

A processor located in each sensor unit evaluates the physical signals recorded by the probes. Thus, the detectors are independent and provide redundancy in case of a failure. Each unit is equipped with a «Power On Self Test», an «Initiated Test» and a «Built In Test Equipment» (BITE) which continuously monitor all components. The «Initiated Test» is triggered by a test input for at least 500 ms.

The detectors are directly connected to the redundant Flight Warning Computers (FWC), which also receive the information, like the Total Air Temperature (TAT), the Weight On Wheel signal, the altitude and the positions of the Nacelle/Wing Anti-Ice pushbuttons. Any fault indication is directly recorded on the Centralized Maintenance Computers (CMC) for A330/A340 (Centralized Fault Data System for A320).

Procedure

If 0,5 +- 0,13 mm of ice is attached to the probe of the detector, which equals a drop in frequency of 133 Hz, the amber ICE DETECTED warning appears on the Engine/Warning Display (E/WD) associated with a MASTER CAUTION and a single chime. The caution is active for 60 seconds. At the same time, the probe is heated until it is free of ice. This usually takes 1 second. The heater continues heating for an additional 6 seconds. In severe icing conditions, this de-icing cycle may be longer. If the heating time reaches 25 seconds, a fault warning is displayed. Both cases inhibit any other indication and cause a Class 2 failure message in the CMC or CFDS, associated to the failed ice detector.

Further ice detection sets a new ice signal flag for 60 seconds. If there are 7 detections accumulated, a «SEVERE ICE DETECTED» warning (MASTER CAUTION, single chime, amber) is given. This corresponds to an ice accretion of approximately 5 mm on the protected wing surface.

This correlation has been validated in extensive flight tests. The «severity» counter is set to zero when the WAI is selected. The ice detection sequence is schematically shown in the figure below.

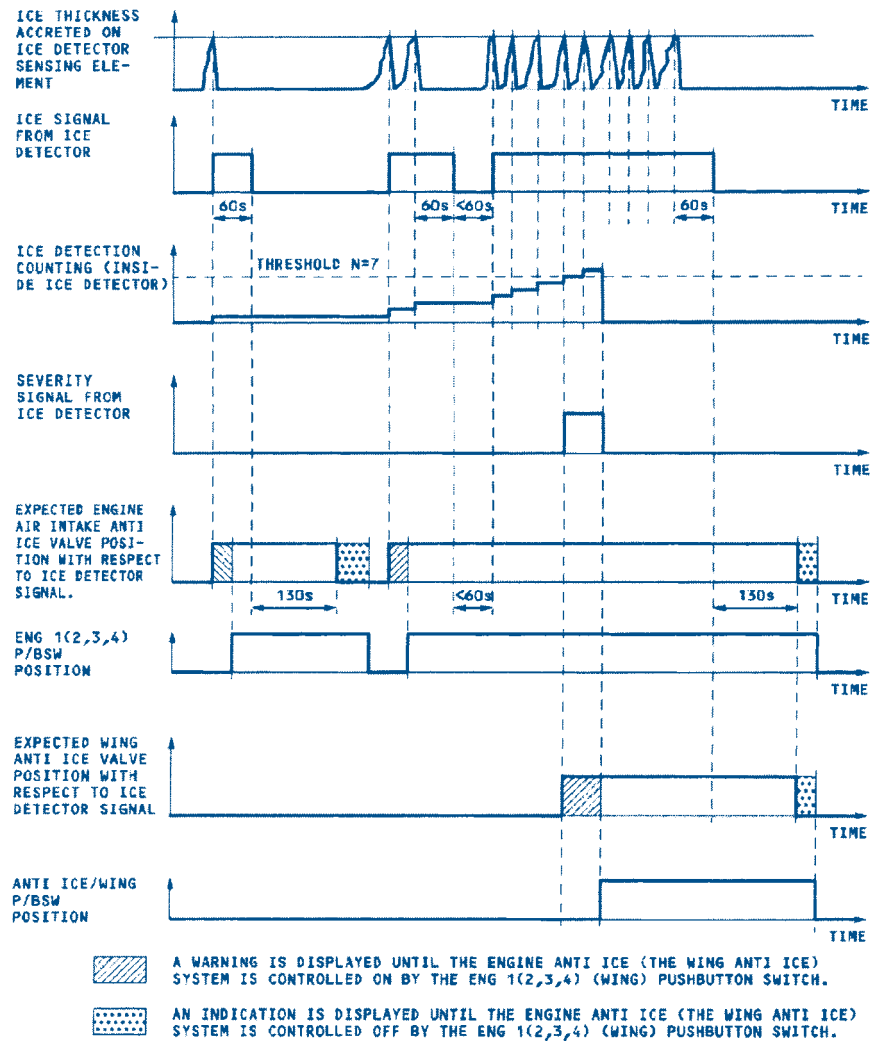

Figure A9 - Ice detection Sequence

The above principle of icing condition detection depends on the ice accretion on the probe. This accretion is only achieved with a certain airspeed. During taxiing, the aircraft is too slow to accrete ice on the probes. An ice accretion due to frost, for example, would lead to a wrong indication. Thus, the system is inhibited by the FWC, if the aircraft is on the ground and below 1500 ft of altitude. All mentioned indications are not announced if the TAT is above +8 °C.

A3.3.3 Primary Ice Detection System

The major difference between a Primary Ice Detection System and the above Dual Advisory Ice Detection System is that the Primary Ice Detection System replaces the AFM/FCOM procedure either by an ice detector indication (manual system) or by an automatic system activation (automatic system). This can be achieved through an increased system redundancy and higher equipment integrity. A possible procedure for a primary automatic ice detection system is shown in the table below. Compared to the

DAIDS the primary system does not further improve aircraft safety, but allows additional fuel saving due to the fact that the AFM procedures can be replaced by less conservative criteria for the activation of the ice protection systems.

Airbus Industrie has intensively studied such a system, but is not convinced of its benefits. Therefore Airbus Industrie has decided not offer a primary system on their aircraft.

	Event	FWC		Panel Indication		Crew Action
		ECAM Engine /Warning display (WARNING/MEMO)	CAUTION	Model Sel	NAI/WAI	
Normal	Ice detected	<i>ICE DETECTED ENG A.ICE / WING A.ICE</i>	Nil		ON (?) ¹	
	Severe ice detected	<i>SEVERE ICE DETECTED</i>	Nil		ON (?) ¹	
	No ice detected	Nil	Nil			
Failure	Computer failure (automatic function)	<u>ANTI ICE AUTO CTL FAULT</u>	MASTER + 🔔	FAULT		ANTI ICE MAN + FCOM procedure
	Probe Failure	<u>ICE DET FAULT</u>	MASTER + 🔔	FAULT		ANTI ICE MAN + FCOM procedure
	NAI / WAI valve / control failure	<u>NAI / WAI FAULT</u> message depending on the failure case	MASTER + 🔔	FAULT	FAULT	ANTI ICE MAN + FCOM procedure

🔔 means Single Chime aural warning

1. means that the button automatically illuminates

Figure A10 - Possible procedure for a primary automatic ice detection system

AIRCRAFT CONTAMINATION IN FLIGHT

Please, bear in mind:

- **Atmospheric physics and meteorology** tell us that icing conditions generally occur from slightly positive °C down to -40 °C and are **most likely around FL100**.

Nevertheless, it should be understood that if severe icing rarely occurs below -12 °C, **slightly positive OATs do not protect from icing and that icing conditions can be potentially met at any FL**.

High accretion rates are not systematically associated with Cumulonimbus; stratiform clouds can ice like hell!

- **Icing conditions** are far **most frequent than effective ice accretion**. Icing conditions do not systematically lead to ice accretion.
- Should the pilot encounter icing conditions in flight, some recommendations are:
 - In addition to using NAI and WAI according to procedures, the pilot should keep an eye on the icing process: Accretion rate, type of cloud.
 - When rapid icing is encountered in a stratiform cloud, a moderate change of altitude will significantly reduce the rate. It is an obligation for the ATC controller to accept altitude change.
 - If icing conditions prevail on the approach, keep speed as high as permitted, delay flap extension as much as possible, and do not retract flaps after landing.
- Ice and snow due to ground precipitation, or overnight stay, should be totally cleared before takeoff, regardless of the thickness. Otherwise aircraft is not certified for flying.
- Optional ice detector systems available on Airbus aircraft are advisory systems and do not replace AFM procedures. For the time being, Airbus Industrie is not convinced of the benefits of a primary ice detection system.

B. AIRCRAFT DE-ICING / ANTI-ICING ON THE GROUND



Bi GENERAL

Safe aircraft operation in cold weather conditions raises specific problems: Aircraft downtime and delays in flight schedules. These can be minimized by a program of preventive cold weather servicing.

The operator must develop procedures for cold weather servicing during cold weather. This servicing must meet their specific requirements, based on:

- Their cold weather experience;
- The available equipment and material;
- The climatic conditions existing at their destinations.

The Chapter 12-31 (Servicing - Aircraft protection) of the Airbus Industrie Aircraft Maintenance Manual (AMM) contains the appropriate information to assist the operator in defining developing and implementing cold weather preventive maintenance procedures that will minimize aircraft downtime and improve the safe operating level of their aircraft in adverse climatic conditions.

B2 DE-/ANTI-ICING AWARENESS CHECKLIST

THE BASIC REQUIREMENTS

1. Responsibility

The person technically releasing the aircraft is responsible for the performance and verification of the results of the de-/anti-icing treatment. The responsibility of accepting the performed treatment lies, however, with the Commander. The transfer of responsibility takes place at the moment the aircraft starts moving under its own power.

2. Necessity

Icing conditions on ground can be expected when air temperatures approach or fall below freezing and when moisture or ice occurs in the form of either precipitation or condensation.

Aircraft-related circumstances could also result in ice accretion, when humid air at temperatures above freezing comes in contact with cold structure.

3. Clean aircraft concept

Any contamination of aircraft surfaces can lead to handling and control difficulties, performance losses and/or mechanical damage.

4. De-icing

Are the conditions of frost, ice, snow or slush such that de-icing is required to provide clean surfaces at engine start?

5. Anti-icing

Is the risk of precipitation such that anti-icing is required to ensure clean surfaces at lift off?

6. Checks

Do you have enough information and adequate knowledge to dispatch the aircraft?

B3 DE-/ANTI-ICING AIRCRAFT ON THE GROUND:

«WHEN, WHY AND HOW»

B3.1 Communication

To obtain the highest possible visibility concerning de-/anti-icing, a good level of communication between ground and flight crews is necessary.

Any observations or points significant to the flight or ground crew should be mutually communicated.

These observations may concern the weather or aircraft-related circumstances or other factors important for the dispatch of the aircraft.

The minimum communication requirements must comprise the details of when the aircraft was de-iced and the quality of treatment (type of fluid).

This is summarized by the anti-icing code [\(see B3.5.5\)](#)

Remember: Uncertainty should not be resolved by transferring responsibility. The only satisfactory answer is clear communication.

Don't rely on someone else to have done the job, unless it is clearly reported as having been done.

B3.2 Conditions which cause aircraft icing [\(see A1\)](#)

● **Weather-related conditions**

Weather conditions dictate the «when» of the «when, why and how» of aircraft de-/anti-icing on the ground.

Icing conditions on the ground can be expected when air temperatures fall below freezing and when moisture or ice occurs in the form of either precipitation or condensation. Precipitation may be rain, sleet or snow. Frost can occur due to the condensation of fog or mist. Frost occurs systematically when OAT is negative and sky is clear overnight.

To these weather conditions must be added further phenomena that can also result in aircraft ice accretion on the ground:

● **Aircraft-related conditions**

The concept of icing is commonly associated only with exposure to inclement weather. However, even if the OAT is above freezing point, ice or frost can form if the aircraft structure temperature is below 0° C (32° F) and moisture or relatively high humidity is present.

With rain or drizzle falling on sub-zero structure, a clear ice layer can form on the wing upper surfaces when the aircraft is on the ground. In most cases this is accompanied by frost on the underwing surface

B3.3 Checks to determine the need to de-ice/anti-ice

B3.3.1 The clean aircraft concept

Why de-ice/anti-ice on ground? The aircraft performance is certified based upon an uncontaminated or clean structure. If the clean aircraft concept were not applied, ice, snow or frost accumulations would disturb the airflow, affect lift and drag, increase weight and result in deterioration.

Aircraft preparation for service begins and ends with a thorough inspection of the aircraft exterior. The aircraft, and especially its surfaces providing lift, controllability and stability, must be aerodynamically clean. Otherwise, safe operation is not possible.

An aircraft ready for flight must not have ice, snow, slush or frost adhering to its critical flight surfaces (wings, vertical and horizontal stabilizers and rudder).

Nevertheless, a **frost layer less than 3mm (1/8 inch) on the underside of the wings**, in the area of fuel tanks, has been accepted by the Airworthiness Authorities without effect on takeoff performance, if it is caused by cold fuel (low fuel temperature, OAT more than freezing and high humidity). Also a thin layer of rime (thin hoar-frost) or a light coating of powdery (loose) snow is acceptable on the upper surface of the fuselage.

Refer to Flight Crew Operating Manual:

Aircraft Type	Chapter	Subject
A300 GE	8.03.14	PROCEDURES AND TECHNIQUES Inclement weather operations - Aircraft preparation for cold weather operation
A300 PW	8.02.11	
A300 FF	2.02.09	
A310 A300-600	2.02.13	
A320 family A330 A340	3.04.91	SUPPLEMENTARY TECHNIQUES Adverse weather - Cold weather



B3.3.2 External inspection

An inspection of the aircraft must visually cover all critical parts of the aircraft and be performed from points offering a clear view of these parts.

In particular, these parts include:

- Wing surfaces including leading edges,
- Horizontal stabilizer upper and lower surface,
- Vertical stabilizer and rudder,
- Fuselage,
- Air data probes,
- Static vents,
- Angle-of-attack sensors,
- Control surface cavities,
- Engines,
- Generally intakes and outlets,
- Landing gear and wheel bays.

B3.3.3 Clear ice phenomenon

Under certain conditions, a clear ice layer or frost can form on the wing upper surfaces when the aircraft is on the ground. In most cases, this is accompanied by frost on the underwing surface. Severe conditions occur with precipitation, when sub-zero fuel is in contact with the wing upper surface skin panels. The **clear ice accumulations are very difficult to detect** from ahead of the wing or behind during walk-around, especially in poor lighting and when the wing is wet. The leading edge may not feel particularly cold. The clear ice may not be detected from the cabin either because wing surface details show through.

The following factors contribute to the formation intensity and the final thickness of the clear ice layer:

- Low temperature of fuel that was added to the aircraft during the previous ground stop and/or the long airborne time of the previous flight, resulting in a situation that the remaining fuel in the wing tanks is below 0° C.
- Abnormally large amount of remaining cold fuel in wing tanks causing the fuel level to be in contact with the wing upper surface panels as well as the lower surface, especially in the wing tank area.
- Temperature of fuel added to the aircraft during the current ground stop, adding (relatively) warm fuel can melt dry, falling snow with the possibility of re-freezing. Drizzle/rain and ambient temperatures around 0°C on the ground is very critical. Heavy freezing has been reported during drizzle/rain even at temperatures of 8 to 14°C (46 to 57°F).

The areas most vulnerable to freezing are:

- The wing root area between the front and rear spars,
- Any part of the wing that contains unused fuel after flight,
- The areas where different wing structures are concentrated (a lot of cold metal), such as areas above the spars and the main landing gear doubler plate.

B3.3.4 General checks

A recommended procedure to check the wing upper surface is to place high enough steps as close as possible to the leading edge and near the fuselage, and climb the steps so that you can touch a wide sector of the tank area by hand. If clear ice is detected, the wing upper surface should be de-iced and then re-checked to ensure that all ice deposits have been removed.

It must always be remembered that below a snow / slush / anti-icing fluid layer there can be clear ice.

During checks on ground, electrical or mechanical ice detectors should only be used as a back-up advisory. **They are not a primary system and are not intended to replace physical checks.**

Ice can build up on aircraft surfaces when descending through dense clouds or precipitation during an approach.

When ground temperatures at the destination are low, it is possible that, when flaps are retracted, accumulations of ice may remain undetected between stationary and moveable surfaces. It is, therefore, important that these areas are checked prior to departure and any frozen deposits removed.

Under freezing fog conditions, it is necessary for the rear side of the fan blades to be checked for ice build-up prior to start-up. Any discovered deposits should be removed by directing air from a low flow hot air source, such as a cabin heater, onto the affected areas.

When slush is present on runways, inspect the aircraft when it arrives at the ramp for slush/ice accumulations. If the aircraft arrives at the gate with flaps in a position other than fully retracted, those flaps which are extended must be inspected and, if necessary, de-iced before retraction.

As mentioned above, the Flight Crew Operating Manual allows takeoff with a certain amount of frost on certain parts of the aircraft (a frost layer less than 3mm (1/8 inch) on the underside of the wings, in the area of fuel tanks and a thin layer of rime or a light coating of powdery (loose) snow on the upper surface of the fuselage.)

This allowance exists to cope mainly with cold fuel, and humid conditions not necessarily linked to winter operations. However, **when the aircraft need to be de-iced, these areas must be also de-iced.**

It is important to note that the rate of ice formation is considerably increased by the presence of an initial depth of ice. Therefore, if icing conditions are expected to occur

along the taxi and takeoff path, it is necessary to ensure that all ice and frost is removed before flight. This consideration must increase flight crew awareness to include the condition of the taxiway, runway and adjacent areas, since surface contamination and blown snow are potential causes for ice accretion equal to natural precipitation.

B3.4 Responsibility: The de-icing/anti-icing decision

- **Maintenance responsibility:**

The information report (de-icing/anti-icing code) given to the cockpit is a part of the technical airworthiness of the aircraft. The person releasing the aircraft is responsible for the performance and verification of the results of the de/anti-icing treatment. The responsibility of accepting the performed treatment lies, however, with the Commander.

- **Operational responsibility:**

The general **transfer of operational responsibility takes place at the moment the aircraft starts moving by its own power.**

B3.4.1 Maintenance / ground crew decision

The responsible ground crew member should be clearly nominated. He should check the aircraft for the need to de-ice. He will, based on his own judgement, initiate de-/anti-icing, if required, and he is responsible for the correct and complete de-icing and/or anti-icing of the aircraft.

B3.3.2 Commander's decision

As the final decision rests with the Commander, his request will supersede the ground crew member's judgement to not de-ice.

As the Commander is responsible for the anti-icing condition of the aircraft during ground maneuvering prior to takeoff, he can request another anti-icing application with a different mixture ratio to have the aircraft protected for a longer period against accumulation of precipitation. Equally, he can simply request a repeat application.

Therefore, the Commander should take into account forecasted or expected weather conditions, taxi conditions, taxi times, holdover time and other relevant factors. The Commander must, when in doubt about the aerodynamic cleanliness of the aircraft, perform (or have performed) an inspection or simply request a further de-/anti-icing.

Even when responsibilities are clearly defined and understood, sufficient communication between flight and ground crews is necessary. Any observation considered valuable should be mentioned to the other party to have redundancy in the process of decision-making.

B3.5 The procedures to de-ice and anti-ice an aircraft

When aircraft surfaces are contaminated by frozen moisture, they must be **de-iced** prior to dispatch. When freezing precipitation exists and there is a risk of precipitation adhering to the surface at the time of dispatch, aircraft surfaces must be **anti-iced**. If both anti-icing and de-icing are required, the procedure may be performed in one or two steps. The selection of a one or two step process depends upon weather conditions, available equipment, available fluids and the holdover time required to be achieved.

When a large holdover time is expected or needed, a two-step procedure is recommended, using undiluted fluid for the second step.

B3.5.1 De-icing

Ice, snow, slush or frost may be removed from aircraft surfaces by heated fluids or mechanical methods.

For maximum effect, fluids shall be applied close to the aircraft surfaces to minimize heat loss.

Different methods to efficiently remove frost, snow, and ice are described in detail in the ISO method specification. Refer also to the Aircraft Maintenance Manual (AMM).

● **General de-icing fluid application strategy**

The following guidelines describe effective ways to remove snow and ice.

Wings/horizontal stabilizers: Spray from the tip towards the root, from the highest point of the surface camber to the lowest.

Vertical surfaces: Start at the top and work downward.

Fuselage: Spray along the top centerline and then outboard; avoid spraying directly onto windows.

Landing gear and wheel bays: Keep application of de-icing fluid in this area to a minimum.

It may be possible to mechanically remove accumulations such as blown snow. However, where deposits have bonded to surfaces they can be removed using hot air or by carefully spraying with hot de-icing fluids. It is not recommended to use a high-pressure spray.

Engines: Deposits of snow should be mechanically removed (for example using a broom or brush) from engine intakes prior to departure. Any frozen deposits, that may have bonded to either the lower surface of the intake or the fan blades, may be removed by hot air or other means recommended by the engine manufacturer.

B3.5.2 Anti-icing

Applying anti-icing protection means that ice, snow or frost will, **for a period of time**, be prevented from adhering to, or accumulating on, aircraft surfaces. This is done by the application of anti-icing fluids.

Anti-icing fluid should be applied to the aircraft surfaces when freezing rain, snow or other freezing precipitation is falling and adhering at the time of aircraft dispatch.

For effective anti-icing protection, an even film of undiluted fluid is required over the aircraft surfaces which are clean or which have been de-iced. For maximum anti-icing protection undiluted, unheated Type II or IV fluid should be used. The high fluid pressures and flow rates normally associated with de-icing are not required for this operation and, where possible, pump speeds should be reduced accordingly. The nozzle of the spray gun should be adjusted to give a medium spray.

The anti-icing fluid application process should be as continuous and as short as possible. Anti-icing should be carried out as near to the departure time as is operationally possible, in order to maintain holdover time. In order to control the uniformity, all horizontal aircraft surfaces must be visually checked during application of the fluid. The required amount will be a visual indication of fluid just beginning to drip off the leading and trailing edges. Most effective results are obtained by commencing on the highest part of the wing section and covering from there towards the leading and trailing edges. On vertical surfaces, start at the top and work down.

The following surfaces should be protected by anti-icing:

- Wing upper surface,
- Horizontal stabilizer upper surface,
- Vertical stabilizer and rudder,
- Fuselage depending upon amount and type of precipitation.

Type I fluids have limited effectiveness when used for anti-icing purposes. Little benefit is gained from the minimal holdover time generated.

B3.5.3 Limits and precautions

Application limits: Under no circumstances can an aircraft that has been anti-iced receive a further coating of anti-icing fluid directly on top of the existing film.

In continuing precipitation, the original anti-icing coating will be diluted at the end of the holdover time and re-freezing could begin. Also a double anti-ice coating should not be applied because the flow-off characteristics during takeoff may be compromised.

Some Type IV fluids may, over a period of time under certain low humidity conditions, thicken and affect the aerodynamic performance of the fluid during subsequent takeoff. If gel residues of Type IV fluids are found at departure, the surface must be cleaned and re-protected as necessary.

Should it be necessary for an aircraft to be re-protected prior to the next flight, the external surfaces must first be de-iced with a hot fluid mix before a further application of anti-icing fluid is made.

The aircraft must always be treated symmetrically - the left hand and right hand sides (e.g. left wing/right wing) must receive the same and complete treatment.

Engines are usually not running or are at idle during treatment. Air conditioning should be selected OFF. The APU may be run for electrical supply but the bleed air valve should be closed.

All reasonable precautions must be taken to minimize fluid entry into **engines, other intakes / outlets** and **control surface cavities**.

Do not spray de-icing / anti-icing fluids directly onto **exhausts** or **thrust reversers**.

De-icing / anti-icing fluid should not be directed into the **orifices of pitot heads, static vents** or directly onto **angle-of-attack sensors**.

Do not direct fluids onto flight deck or cabin windows because this can cause **cracking of acrylics** or **penetration of the window sealing**.

All doors and windows must be closed to prevent:

- **Galley floor areas** being contaminated with slippery de-icing/anti-icing fluids
- **Upholstery** becoming soiled.

Any forward area from which fluid may blow back onto **windcreens** during taxi or subsequent takeoff should be **free of fluid residues** prior to departure. If Type II or IV fluids are used, all traces of the fluid on flight deck windows should be removed prior to departure, with particular attention being paid to windows fitted with wipers.

De-icing/anti-icing fluid can be removed by rinsing with clear water and wiping with a soft cloth. Do not use the windscreen wipers for this purpose. This will cause smearing and loss of transparency.

Landing gear and **wheel bays** must be kept free from build-up of slush, ice or accumulations of blown snow.

Do not spray de-icing fluid directly onto hot **wheels or brakes**.

When removing ice, snow or slush from aircraft surfaces, care must be taken to prevent it entering and accumulating in **auxiliary intakes** or **control surface hinge areas**, i.e. remove snow from wings and stabilizer surfaces forward towards the leading edge and remove from ailerons and elevators back towards the trailing edge.

Do not close any door until all ice has been removed from the surrounding area.

A functional **flight control check** using an external observer may be required after de-icing / anti-icing. This is particularly important in the case of an aircraft that has been subjected to an extreme ice or snow covering.

B3.5.4 Checks

- **Final check before aircraft dispatch**

No aircraft should be dispatched for departure under icing conditions or after a de-icing / anti-icing operation unless the aircraft has received a **final check** by a responsible authorized person.

The inspection must visually cover all critical parts of the aircraft and be performed from points offering sufficient visibility on these parts (e.g. from the de-icer itself or another elevated piece of equipment). It may be necessary to gain direct access to physically check (e.g. by touch) to ensure that there is no clear ice on suspect areas.

- **Pre takeoff check**

When freezing precipitation exists, it may be appropriate to check aerodynamic surfaces just prior to the aircraft taking the active runway or initiating the takeoff roll in order to confirm that they are free of all forms of frost, ice and snow. This is particularly important when severe conditions are experienced, or when the published holdover times have either been exceeded or are about to run out.

When deposits are in evidence, it will be necessary for the de-icing operation to be repeated.

If the takeoff location cannot be reached within a reasonable time, and/or a reliable check of the wing upper surface status cannot be made from inside the aircraft, consider a repeat aircraft treatment.

If aircraft surfaces cannot adequately be inspected from inside the aircraft, it is desirable to provide a means of assisting the flight crew in determining the condition of the aircraft. The inspection should be conducted as near as practical to the beginning of the departure runway.

When airport configuration allows, it is desirable to provide de-icing/anti-icing and inspection of aircraft near the beginning of departure runways to minimize the time interval between aircraft de-icing / anti-icing and takeoff, under conditions of freezing precipitation.

B3.5.5 Flight crew information / communication

No aircraft should be dispatched for departure after a de-icing / anti-icing operation unless the flight crew has been notified of the **type of de-icing / anti-icing operation** performed. The ground crew must make sure that the flight crew has been informed. The flight crew should make sure that they have the information.

This information includes the results of the final inspection by qualified personnel, indicating that the aircraft critical parts are free of ice, frost and snow. It also includes the necessary anti-icing codes to allow the flight crew to estimate the holdover time to be expected under the prevailing weather conditions.

● Anti-icing codes

It is essential that the flight crew receive clear information from ground personnel concerning the treatment applied to the aircraft.

The AEA (Association of European Airlines) recommendations and the SAE and ISO specifications promote the standardized use of a four-element code. This gives flight crew the minimum details to assess holdover times. The use of local time is preferred but, in any case, statement of the reference is essential. This information must be recorded and communicated to the flight crew by referring to the last step of the procedure.

Examples of anti-icing codes:

AEA Type II/75/16.43 local TLS / 19 Dec 99

AEA Type II : Type of fluid used
75 : Percentage of fluid/water mixtures by volume 75% fluid / 25% water
16.43 : Local time of **start** of last application
19 Dec 99 : Date

ISO Type I/50:50/06.30 UTC/ 19 Dec 99

50:50 : 50% fluid / 50 % water
06.30 : Time (UTC) of **start** of last application

● Fluid application and holdover time guidelines

Holdover protection is achieved by anti-icing fluids remaining on and **protecting aircraft surfaces for a period of time**.

With a one-step de/anti-icing operation, holdover begins at the start of the operation. With a two-step operation, holdover begins at the start of the second (anti-icing) step. Holdover time will have effectively run out, when frozen deposits start to form/accumulate on aircraft surfaces.

Due to its properties Type I fluid forms a thin liquid-wetting film, which gives a rather limited holdover time, depending on weather conditions. With this type of fluid, increasing the concentration of fluid in the fluid/water mix would provide no additional holdover time. Type II and Type IV fluids contain a thickener which enables the fluid to form a thicker liquid-wetting film on external surfaces. This film provides a longer holdover time, especially in conditions of freezing precipitation. With this type of fluid, additional holdover time will be provided by increasing the concentration of fluid in the fluid/water mix, with maximum holdover time available from undiluted fluid.

Tables 1, 2 and 3 below provide an indication of the protection timeframe of that could reasonably be expected under precipitation conditions.

However, due to the many variables that can influence holdover times, these times **should not be considered as minimum or maximum, since the actual time of protection may be extended or reduced**, depending upon the particular conditions existing at the time.

The lower limit of the published time span is used to indicate the estimated time of protection during heavy precipitation and the upper limit, the estimated time of protection during light precipitation.

Caution:

The protection times represented in these tables are for general information purposes only. They are taken from the ISO/SAE specifications, effective October 1st, 1999. However, local authority requirements may differ.

The protection time will be shortened in severe weather conditions. Heavy precipitation rates or high moisture content, high wind velocity and jet blast may cause a degradation of the protective film. If these conditions occur, the protection time may be shortened considerably. This is also the case when the aircraft skin temperature is significantly lower than the outside air temperature.

The indicated times should, therefore, only be used in conjunction with a pre-takeoff check.

All de/anti-icing fluids following the specifications mentioned below are approved for all Airbus aircraft:

- Type I : SAE AMS 1424 standard
- Type II : SAE AMS 1428 standard
- Type IV : SAE AMS 1428C standard

The list of approved fluids is given in AMM 12.31

Table 1**Guidelines for holdover times anticipated for SAE Type I fluid mixture as a function of weather conditions and OAT****CAUTION: This table is for use in departure planning only, and it should be used in conjunction with pre-takeoff check procedures.**

OAT		Approximate holdover times under various weather conditions (hours: minutes)						
°C	°F	Frost (*)	Freezing Fog	Snow	Freezing Drizzle (**)	Light Freezing Rain	Rain on Cold Soaked Wing	Others (1)
above 0	above 32	0:45	0:12-0:30	0:06-0:15	0:05-0:08	0:02-0:05	0:02-0:05	CAUTION: No holdover time guidelines exist
0 to -10	32 to 14	0:45	0:06-0:15	0:06-0:15	0:05-0:08	0:02-0:05	CAUTION: Clear ice may require touch for confirmation	
below -10	below 14	0:45	0:06-0:15	0:06-0:15				

°C: Degrees Celsius - °F: Degrees Fahrenheit - OAT: Outside Air Temperature

THE RESPONSIBILITY FOR THE APPLICATION OF THESE DATA REMAINS WITH THE USER.

(*) During conditions that apply to aircraft protection for ACTIVE FROST ([See General notes hereafter](#))

(**) Use light freezing rain holdover times if positive identification of freezing drizzle is not possible.

(1) Snow pellets, snow grains, ice pellets, moderate and heavy freezing rain, hail ([See General notes hereafter](#))

SAE Type I fluid/water mixture is selected so that the freezing point of the mixture is at least 10(C (18(F) below OAT

CAUTION: The time of protection will be shortened in heavy weather conditions. Heavy precipitation rates or high moisture content, high wind velocity or jet blast will reduce holdover time below the lowest time stated in the range. Holdover time may be reduced when aircraft skin temperature is lower than OAT.**CAUTION:** SAE Type I fluid used during ground de-icing/anti-icing is not intended for and does not provide protection during flight.

Table 2

Guidelines for holdover times anticipated for SAE Type II fluid mixtures as a function of weather conditions and OAT

CAUTION: This table is for use in departure planning only, and it should be used in conjunction with pre-takeoff check procedures.

OAT		SAE Type II fluid concentration Neat-fluid/water (Vol. %/Vol. %)	Approximate holdover times under various weather conditions (hours: minutes)						
°C	°F		Frost (*)	Freezing fog	Snow	Freezing drizzle (***)	Light freezing rain	Rain on cold soaked wing	Others (1)
above 0	above 32	100/0	12:00	1:05-2:15	0:20-1:00	0:30-1:00	0:15-0:30	0:05-0:40	CAUTION: No holdover time guidelines exist
		75/25	6:00	0:50-1:45	0:15-0:40	0:20-0:45	0:10-0:25	0:05-0:25	
		50/50	4:00	0:15-0:35	0:05-0:15	0:05-0:20	0:05-0:10		
0 to -3	32 to 27	100/0	8:00	0:35-1:30	0:20-0:45	0:30-1:00	0:15-0:30	CAUTION: Clear ice may require	
		75/25	5:00	0:25-1:00	0:15-0:30	0:20-0:45	0:10-0:25	touch for	
		50/50	3:00	0:15-0:35	0:05-0:15	0:05-0:20	0:05-0:10	confirmation	
below -3 to -14	below 27 to 7	100/0	8:00	0:30-1:05	0:15-0:35	0:15-0:45 (**)	0:10-0:30 (**)		
		75/25	5:00	0:20-0:55	0:15-0:25	0:15-0:30 (**)	0:10-0:20 (**)		
below -14 to -25	below 7 to -13	100/0	8:00	0:15-0:20	0:15-0:30				
below -25	below -13	100/0	SAE Type II fluid may be used below -25°C (-13°F) provided the freezing point of the fluid is at least 7°C (13°F) below the OAT and the aerodynamic acceptance criteria are met. Consider use of SAE Type I when SAE Type II fluid cannot be used.						

°C: Degrees Celsius - °F: Degrees Fahrenheit - OAT: Outside Air Temperature - Vol: Volume

THE RESPONSIBILITY FOR THE APPLICATION OF THESE DATA REMAINS WITH THE USER.

(*) During conditions that apply to aircraft protection for ACTIVE FROST ([See General notes hereafter](#))

(**) No holdover time guidelines exist for this condition below -10 (C (14 (F)

(***) Use light freezing rain holdover times if positive identification of freezing drizzle is not possible

(1) Snow pellets, snow grains, ice pellets, moderate and heavy freezing rain, hail ([See General notes hereafter](#))

CAUTION: The time of protection will be shortened in heavy weather conditions. Heavy precipitation rates or high moisture content, high wind velocity or jet blast may reduce holdover time below the lowest time stated in the range. Holdover time may be reduced when aircraft skin temperature is lower than OAT.

CAUTION: SAE Type II fluid used during ground de-icing/anti-icing is not intended for and does not provide protection during flight.

Effective: October 1, 1999

Table 3

Guidelines for holdover times anticipated for SAE Type IV fluid mixtures as a function of weather conditions and OAT

CAUTION: This table is for use in departure planning only, and it should be used in conjunction with pre-takeoff check procedures.

OAT		SAE Type IV fluid concentration Neat-fluid/water (Vol. %/Vol. %)	Approximate holdover times under various weather conditions (hours: minutes)						
°C	°F		Frost (*)	Freezing fog	Snow	Freezing drizzle (***)	Light freezing rain	Rain on cold soaked wing	Others (1)
above 0	above 32	100/0	18:00	1:05-2:15	0:35-1:05	0:40-1:00	0:25-0:40	0:10-0:50	CAUTION: No holdover time guidelines exist
		75/25	6:00	1:05-1:45	0:20-0:40	0:30-1:00	0:15-0:30	0:05-0:35	
		50/50	4:00	0:20-0:35	0:05-0:20	0:10-0:20	0:05-0:10		
0 to -3	32 to 27	100/0	12:00	1:05-2:15	0:30-0:55	0:40-1:00	0:25-0:40	CAUTION: Clear ice may require touch for confirmation	
		75/25	5:00	1:05-1:45	0:20-0:35	0:30-1:00	0:15-0:30		
		50/50	3:00	0:20-0:35	0:05-0:15	0:10-0:20	0:05-0:10		
below -3 to -14	below 27 to 7	100/0	12:00	0:40-1:30	0:20-0:40	0:20-0:55 (**)	0:10-0:30 (**)		
		75/25	5:00	0:25-1:00	0:15-0:25	0:20-0:55 (**)	0:10-0:30 (**)		
below -14 to -25	below 7 to -13	100/0	12:00	0:20-0:40	0:15-0:30				
below -25	below -13	100/0	SAE Type IV fluid may be used below -25°C (-13°F) provided the freezing point of the fluid is at least 7°C (13°F) below the OAT and the aerodynamic acceptance criteria are met. Consider use of SAE Type I when SAE Type IV fluid cannot be used.						

°C: Degrees Celsius - °F: Degrees Fahrenheit - OAT: Outside Air Temperature - Vol: Volume

THE RESPONSIBILITY FOR THE APPLICATION OF THESE DATA REMAINS WITH THE USER.

(*) During conditions that apply to aircraft protection for ACTIVE FROST ([See General notes hereafter](#))

(**) No holdover time guidelines exist for this condition below -10 (C (14 (F)

(***) Use light freezing rain holdover times if positive identification of freezing drizzle is not possible

(1 Snow pellets, snow grains, ice pellets, moderate and heavy freezing rain, hail ([See General notes hereafter](#))

CAUTION: The time of protection will be shortened in heavy weather conditions. Heavy precipitation rates or high moisture content, high wind velocity or jet blast may reduce holdover time below the lowest time stated in the range. Holdover time may be reduced when aircraft skin temperature is lower than OAT.

CAUTION: SAE Type IV fluid used during ground de-icing/anti-icing is not intended for and does not provide protection during flight.

● General Notes

- ACTIVE FROST means that the weather conditions are such that frost is actually forming. This is in contrast to the situation where frost has formed on the airplane, but frost no longer forms at the time of de-icing. In that case, no protection for frost re-formation needed if the frost was still actively forming is needed after the de-icing.
- The Flight Standard Information Bulletin for Transportation (FSAT 99-07) effective date 01 October 1999 publishes the FAA-approved de-icing program updates for winter 1999-2000. It includes revised SAE-approved holdover time guideline charts (reproduced here above). On all these charts a new column has been added with a heading of «Others (1)». This new column, with its supporting note, delineates the fact that no holdover time guidelines exist for the conditions of snow pellets, snow grains, ice pellets, moderate and heavy freezing rain and hail.
FSAT 99-07 also mentions that, as such, air carriers should not attempt takeoff in conditions of snow pellets, snow grains, ice pellets or hail unless operations in these conditions are approved by the aircraft manufacturer and a pre-takeoff contamination check is performed. Takeoffs in conditions of moderate and heavy freezing rain are not approved.
Airbus Industrie does not approve takeoff in any of the above-mentioned conditions (i.e. snow pellets, snow grains, ice pellets or hail). Indeed, the requirement is to comply with the clean aircraft concept; i.e. no precipitation accumulation is permitted on the aircraft during takeoff.
Therefore, as long as no holdover times exist for conditions of snow pellets, snow grains, ice pellets or hail, takeoff in these conditions is not recommended.
- FSAT 99-07 also publishes additional FAA-approved manufacturer specific Type II and Type IV de-icing / anti-icing holdover time tables.

Table 4
 Guidelines for the application of SAE Type I fluid mixtures.

Minimum concentrations as a function of Outside Air Temperature (OAT)

Outside Air Temperature OAT	One-step Procedure De-icing/anti-icing	Two-step Procedure	
		First step: De-icing	Second step Anti-icing (*)
-3° C (27° F) and above	Freezing point of heated fluid (**) mixture shall be at least 10° C (18° F) below OAT	Water heated to 60° C (140° F) minimum at the nozzle or a heated mix of fluid and water	Freezing point of fluid mixture shall be at least 10° C (18° F) below actual OAT
Below -3° C (27° F)		Freezing point of heated fluid mixture shall not be more than 3° C (5° F) above OAT	
<p>Note: For heated fluids, a fluid temperature not less than 60° C (140° F) at the nozzle is desirable. Upper temperature limit shall not exceed 90°C or fluid manufacturers recommendations.</p> <p>Caution: Wing skin temperatures may differ and in some cases may be lower than OAT. A stronger mix (more Glycol) can be used under the latter conditions.</p>			
<p>(*) To be applied before first step fluid freezes, typically within 3 minutes. (**) Clean aircraft may be anti-iced with unheated fluid.</p>			

Effective: October 1, 1999

Table 5

Guidelines for the application of SAE Type II and Type IV fluid mixtures.

Minimum Concentrations as a function of Outside Air Temperature (OAT)

Outside Air Temperature OAT	One-step Procedure De-icing/anti-icing	Two-step Procedure	
		First step: De-icing	Second step Anti-icing (*)
-3° C (27° F) and above	50/50 Heated (**) Type II/IV	Water heated or a heated mix of Type I, II or IV with water	50/50 Type II/IV
Below -3° C (27° F) to -14° C (7° F)	75/25 Heated (**) Type II/IV	Heated suitable mix of Type I, Type II/IV and water with FP not more than 3° C (5° F) above actual OAT	75/25 Type II/IV
Below -14° C (7° F) to -25° C (-13° F)	100/0 Heated (**) Type II/IV	Heated suitable mix of Type I, Type II/IV and water with FP not more than 3° C (5° F) above actual OAT	100/0 Type II/IV
Below -25° C	SAE Type II/IV fluid may be used below -25° C (-13° F) provided that the freezing point of the fluid is at least a 7° C (13° F) below OAT and that aerodynamic acceptance criteria are met. Consider the use of SAE Type I when Type II/IV fluid cannot be used (see table 1).		
<p>NOTE: For heated fluids, a fluid temperature not less than 60° C (140° F) at the nozzle is desirable. Upper temperature limit shall not exceed 90°C or fluid manufacturers recommendations.</p> <p>CAUTION: Wing skin temperatures may differ and in some cases may be lower than OAT. A stronger mix can be used under the latter conditions.</p>			
<p>(*) Clean aircraft may be anti-iced with unheated fluid. (**) To be applied before first step fluid freezes, typically within 3 minutes.</p>			
<p>Caution: An insufficient amount of anti-icing fluid, especially in the second step of a two-step procedure may cause a substantial loss of holdover time, particularly when using a Type I fluid mixture for the first step (de-icing).</p>			

Effective: October 1, 1999

B3.6 Pilot techniques

This section addresses the issue of ground de-icing/anti-icing from the pilot's point of view. The topic is covered in the order it appears on cockpit checklists and is followed through, step-by-step, from flight preparation to takeoff. The focus is on the main points of decision-making, flight procedures and pilot techniques.

For additional information refer to the FCOM:

Aircraft Type	Chapter	Subject
A300 GE	8.03.14	PROCEDURES AND TECHNIQUES
A300 PW	8.02.11	Inclement weather operations
A300 FF	2.02.09	- Aircraft preparation for cold weather operation
A310	2.02.13	
A300-600		
A320 family	3.04.91	SUPPLEMENTARY TECHNIQUES
A330		Adverse weather
A340		- Cold weather

B3.6.1 Receiving aircraft

When arriving at the aircraft, local advice from ground maintenance staff may be considered, because they may be more familiar with local weather conditions. If there is nobody available, or if there is any doubt about their knowledge concerning de-icing/anti-icing aspects, pilots have to determine the need for de-icing/anti-icing by themselves.

Checks for the need to de-ice/anti-ice are presented in [section B3.3](#) and the methods in [section B3.5](#).

If the prevailing weather conditions call for protection during taxi, pilots should try to determine «off block time» to be in a position to get sufficient anti-icing protection regarding holdover time.

This message should be passed on to the de-icing/anti-icing units, the ground maintenance, the boarding staff, the dispatch office and all other units involved.

B3.6.2 Cockpit preparation

Before treatment, avoid pressurizing or testing flight control systems.

Try to make sure that all flight support services are completed prior to treatment, to avoid any delay between treatment and start of taxiing.

During treatment observe that:

- Engines are shut down or at idle,
- APU may be used for electrical supply,
- All air bleeds should be OFF,
- All external lights of treated areas should be OFF.

Consider whether communication and information with the ground staff is/has been adequate.

A specific item included in the normal cockpit preparation procedures is recommended.

The minimum requirement is to receive the anti-icing code in order to figure out the available protection time from the holdover timetable.

Do not consider the information given in the holdover timetables as precise. There are several parameters influencing holdover time.

The timeframes given in the holdover timetables consider the very different weather situations worldwide. The view of the weather is rather subjective; experience has shown that a certain snowfall can be judged as light, medium or heavy by different people. If in doubt, a pre-takeoff check should be considered.

As soon as the treatment of the aircraft is completed, proceed to engine starting. Regarding responsibility and decision, [see section B3.4](#).

B3.6.3 Taxiing

During taxiing, the flight crew should observe the intensity of precipitation and keep an eye on the aircraft surfaces visible from the cockpit. Ice warning systems of engines and wings or other additional ice warning systems must be considered.

Sufficient distance from the preceding aircraft must be maintained, as blowing snow or jetblasts can degrade the anti-icing protection of the aircraft.

The extension of slats and flaps should be delayed, especially when operating on slushy areas. However, in this case slat/flap extension should be verified prior to takeoff.

B3.6.4 Takeoff

Recommendations provided in the aircraft-specific FCOM, regarding performance corrections or procedures applied when operating in icing conditions should be considered.

B3.6.5 General remarks

In special situations, flight crews must be encouraged not to allow operational or commercial pressures to influence decisions. The minimum requirements have been presented here, as well as the various precautions.

If there is any doubt as to whether the aircraft is contaminated - **do NOT takeoff**.

As in any other business, the key factors to ensuring efficient and safe procedures are: Awareness, understanding and communication.

If there is any doubt or question at all, ground and flight crews must communicate with each other.

B4 FLUID CHARACTERISTICS AND HANDLING

B4.1 De-icing/anti-icing fluids - characteristics

Although numerous fluids are offered by several manufacturers worldwide, fluids can be principally divided into two classes, Type I and Type II/IV fluids.

B4.1.1 Type I fluid characteristics

- No thickener system
- Minimum 80% glycol content
- Newtonian fluid: Viscosity depends on temperature
- Relatively short holdover time

Depending on the respective specification, they contain at least 80 percent per volume of either monoethylene-, diethylene- or monopropylene glycol or a mixture of these glycols. The rest comprises water, inhibitors and wetting agents. The inhibitors act to restrict corrosion, to increase the flash point or to comply with other requirements regarding materials' compatibility and handling. The wetting agents allow the fluid to form a uniform film over the aircraft's surfaces.

Type I fluids show a relatively low viscosity which only changes depending on temperature. Glycols can be well-diluted with water. The freezing point of a water/glycol mixture varies with the content of water, whereas the concentrated glycol does not show the lowest freezing point: This is achieved with a mixture of approximately 60% glycol and 40% water (freezing point below -50°C). The freezing point of the concentrated monoethylene, diethylene or propylene glycol is in the range of -10°C . Therefore Type I fluids are normally diluted with water of the same volume. This 50/50 mixture has a lower freezing point than the concentrated fluid and, due to the lower viscosity, it flows off the wing much better.

B4.1 - Type II/IV fluid characteristics

- With thickener system
- Minimum 50 percent glycol-
- Pseudo-plastic or non Newtonian fluid: Viscosity depends on temperature and shear forces to which the fluid is exposed
- Relatively long holdover time

Type II/IV fluids contain at least 50% per volume monoethylene-, diethylene- or propyleneglycol, different inhibitors, wetting agents and a thickener system giving the fluid a high viscosity. The rest is water.

Although the thickener content is less than 1%, it gives the fluid particular properties. The viscosity of the fluid and the wetting agents causes the fluid to disperse onto the sprayed aircraft surface, and acts like a protective cover.

The fundamental idea is a lowering of the freezing point. Due to precipitation such as snow, freezing rain or any other moisture, there is a dilution effect on the applied fluid. This leads to a gradual increase of the freezing point until the diluted fluid layer is frozen due to the low ambient temperature. By increasing the viscosity, a higher film thickness exists having a higher volume which can therefore absorb more water before freezing point is reached. In this way, the holdover time is increased.

The following summarizes the properties of particular constituents of Type II and IV fluids:

- The **glycol** in the fluid reduces the freezing point to negative ambient temperatures.
- The **wetting agent** allows the fluid to form a uniform film over the aircraft's surfaces.
- The **thickening agent** in Type II and IV fluids enables the film to remain on the aircraft's surfaces for longer periods.

Type II and IV fluids can be diluted with water. Because of the lower glycol content, compared to the Type I fluids, the freezing point rises all the time as water is added. The viscosity of Type II and IV fluids is a function of the existing shear forces. Fluids showing decreasing viscosity at increasing shear forces have pseudo-plastic or non-Newtonian flow properties.

During aircraft take-off, shear forces emerge parallel to the airflow at the fluid and aircraft surface. With increasing speed the viscosity decreases drastically and the fluid flows off the wing.

The protective effect of the Type II and IV fluids is much better when compared to the Type I fluids. Therefore they are most efficient when applied during snowfall, freezing rain and/or with long taxiways before take-off.

Type II/IV and Type I fluids can all be diluted with water. This may be done if due to

weather conditions, no long conservation time is needed or higher freezing points are sufficient.

All above types of fluid have to meet the specified anti-icing performance and aerodynamic performance requirements as established in the respective specifications (ISO, SAE, AEA). This has to be demonstrated by the fluid manufacturer.

- **Anti-icing process**

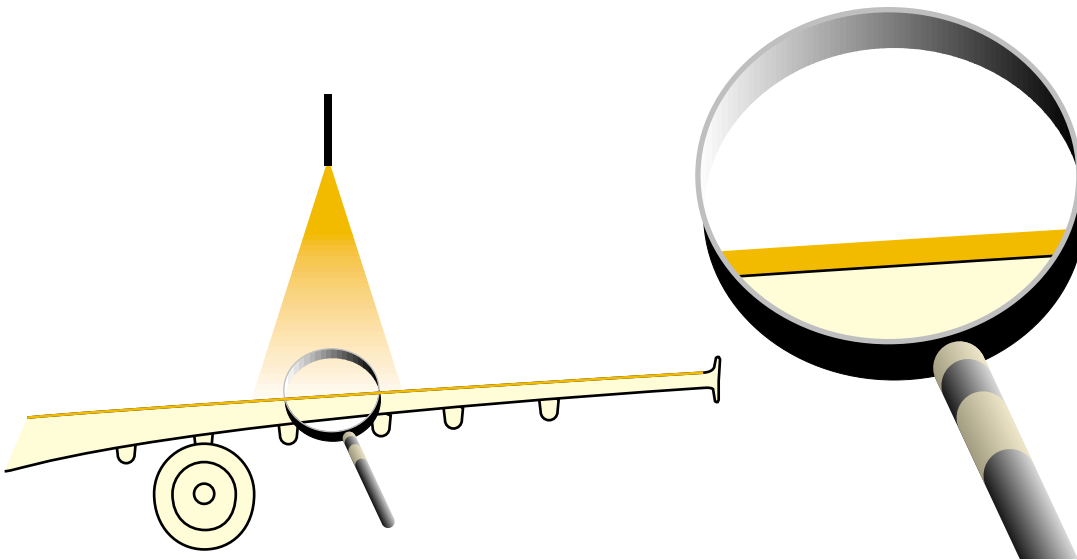

The anti-icing fluid which freezes at a very low temperature (e.g. -30°C), is applied on a clean surface. It forms a protective layer.

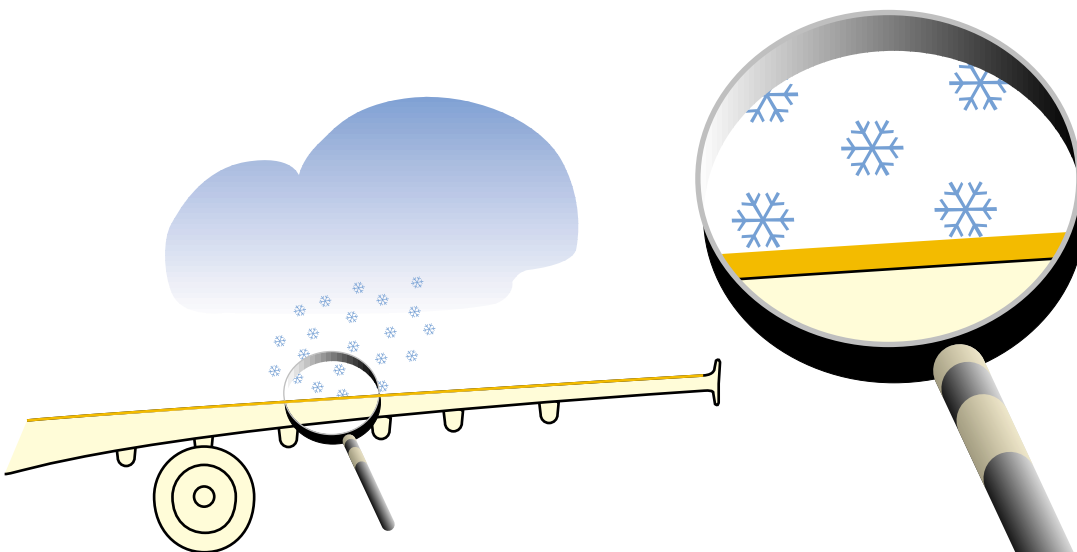

This fluid layer absorbs the frozen precipitation. It keeps the freezing temperature of the diluted fluid well below OAT or aircraft skin temperature, thus preventing frozen precipitation to accumulate.

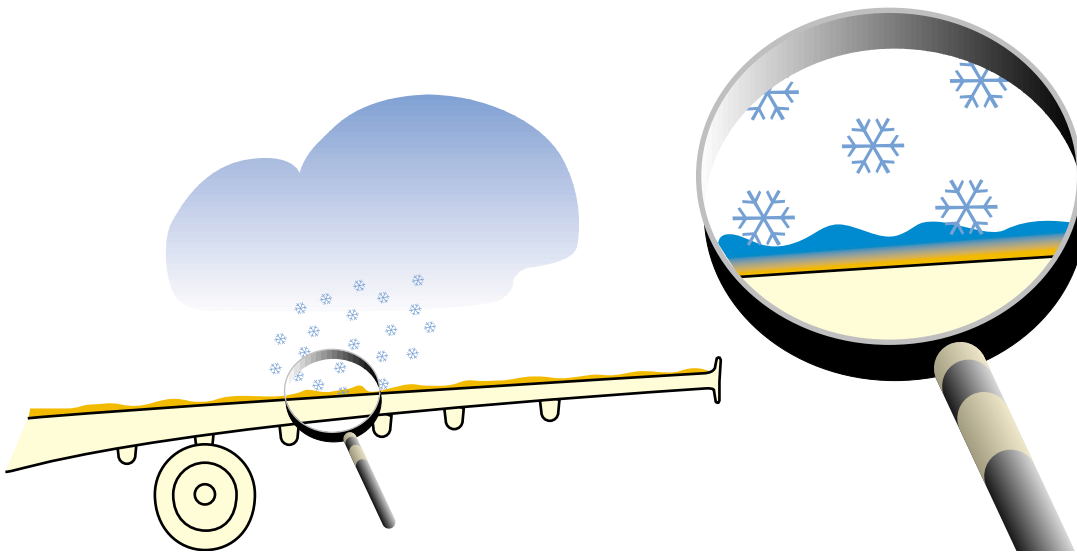

Then the layer becomes more and more diluted by the melted precipitation; its freezing temperature increases. When it reaches OAT or the aircraft skin temperature, anti-icing fluid fails and the frozen precipitation accumulates.

Exceeding the holdover time means that the anti-icing fluid has failed and lost its effectiveness, i.e. frozen precipitation is no longer absorbed by the diluted anti-icing fluid, making the protection ineffective.

The precipitation accumulates

→ Clean aircraft concept not fulfilled

→ Danger!!!

B4.2 Fluid handling

● **General**

De-icing/anti-icing fluids are chemical products with an environmental impact. During fluid handling, avoid any unnecessary spillage, comply with local environmental and health laws and the manufacturer's safety data sheet.

Mixing of products from different suppliers is generally not allowed and needs extra qualification testing.

Slippery conditions due to the presence of fluid may exist on the ground or on equipment following the de-icing/anti-icing procedure. Caution should be exercised due to increased slipperiness, particularly under low humidity or non-precipitating weather conditions.

● **Fluid handling equipment**

The following information is generally valid for all types of fluid, but especially for Type II and IV fluids.

As the structure of Type II and IV fluids is relatively complicated to comply with several requirements, they are rather sensitive with regards to handling.

The holdover time, as one of the most important criteria, is gained essentially by viscosity. The visco-elastic property of the fluid can be adversely affected by overheating, mechanical shearing and contamination by corroded tanks, in such a manner that the expected and required holdover times cannot be achieved.

Therefore trucks, storage tanks and dressing plants have to be adequately conceived and maintained to comply with these requirements.

Fluid shearing occurs when adjacent layers of fluid are caused to move relative to one another, whether in opposite directions or in the same direction at different speeds. This condition is unavoidable when pumping a fluid. For example, when merely moving a fluid through a pipe, fluid velocity ranges from zero at the pipe wall to a maximum at the center. Type II and IV fluids are damaged when the magnitude of shear is sufficient to break the long-polymer chains that make up the thickener. Therefore, specific equipment must be used.

● **Storage**

Tanks dedicated to the storage of the de-icing/anti-icing fluid are required. The tanks should be made of a construction material compatible with the de-icing/anti-icing fluid, as specified by the fluid manufacturer. They should be conspicuously labeled to avoid contamination.

Tanks should be inspected annually for corrosion and/or contamination. If corrosion or contamination is evident, tanks should be maintained to standard or replaced. To prevent corrosion at the liquid/vapor interface and in the vapor space, a high liquid level in the tanks is recommended.

The storage temperature limits must comply with the manufacturer's guidelines. The stored fluid shall be routinely checked to ensure that no degradation or contamination has taken place.

- **Pumping**

De-icing/anti-icing fluids may show degradation caused by excessive mechanical shearing. Therefore, only compatible pumps as well as compatible spraying nozzles should be used. The design of the pumping systems must be in accordance with the fluid manufacturer's recommendations.

- **Transfer lines**

Dedicated transfer lines must be conspicuously labeled to prevent contamination and must be compatible with the de-icing/anti-icing fluids to be transferred. An in-line filter, constructed according to the fluid manufacturer's recommendations, is recommended to remove any solid contaminant.

- **Heating**

De-icing/anti-icing fluids must be heated according to the fluid manufacturer's guidelines. The integrity of the fluid following heating in storage should be checked periodically, by again referring to the fluid manufacturer's guidelines. Such checks should involve at least checking the refractive index and viscosity.

- **Application**

Application equipment shall be cleaned thoroughly before the first fill with de-icing/anti-icing fluid, in order to prevent fluid contamination. Fluid in trucks should not be heated in confined or poorly ventilated areas such as hangars. The integrity (viscosity) of the Type II and IV fluids at the spray nozzle should be checked annually, preferably at the beginning of the winter season.

B4.3 Environment and health

Besides water, de-icing/anti-icing fluids contain glycols and different additives as main ingredients. Type II and IV fluids also contain a thickener system.

The glycols used are bivalent alcohols. Glycols are colorless fluids with a sweet taste (not recommended to try).

Regarding environmental compatibility, the most important criteria are biodegradability and toxicity.

- **Biological degradation**

The single glycols, like monoethylene, diethylene and propyleneglycol, are entirely biodegradable. Biodegradable means that a conversion is achieved by aerobic bacteria changing glycol to water and carbon dioxide by the aid of oxygen.

For the different glycols, there are minor differences with regards to the rapidity of biodegradation and the oxygen used. Also, the temperature is an important parameter. Biodegradation results faster at higher temperatures, and slower at lower temperatures. The best way to handle waste fluids is to drain them into local waste water treatment plants. Fluids can be drained into surface waters during winter, as the oxygen content will be higher than during summer. The colder the water, the more oxygen is available. Substantial drainage into surface waters during summer is not ideal as the biodegradation occurs faster and, moreover, less oxygen is available. The overall effect on surface waters can be adverse in such a case.

The glycols mentioned are practically non-toxic versus bacteria. Exceptionally high amounts (10 to 20 grams per liter water) would be necessary to adversely affect the biodegradation. These concentrations are effectively never reached, therefore biodegradation generally occurs. Nevertheless, caution should be exercised in this matter. The thickener system of Type II and IV fluids, approximately 1% of volume of the fluid, is totally neutral to the environment. It will not be biodegraded but has no negative effects on the environment; it may be compared to a pebble.

The additives and inhibitors can have an effect on the overall biodegradability. In any case, the fluids have to meet local regulations concerning biodegradability and toxicity.

● **Toxicity**

Although biodegradable, monoethylene-glycol should be considered as harmful if swallowed. The principal toxic effects of ethylene glycol are kidney damage, in most cases with fatal results.

Several reports concerning the toxicity of diethyleneglycol showed that it can be compared to glycerin in this matter; glycerin is considered to be non-toxic.

Propyleneglycol is classified as non-toxic. A special pure quality is used in the pharmaceutical, cosmetic, tobacco and beverages industry. Propyleneglycol is not irritating and the conversion in the human body occurs via intermediate products of the natural metabolism.

However, the standard precautions taken when handling chemicals should be adopted when handling glycols.

● **Protective clothes**

Precautions include preventive skin protection by using suitable skin ointment and wearing thick protective clothing, as well as waterproof gloves.

Due to the possibility of atomization, protective glasses should also be worn. Soaked clothes should be changed and, after each de-icing / anti-icing activity, the face and hands should be washed with water.

Further details are available from the fluid manufacturers and the material data sheets for their products.

B4.4 De-anti/anti-icing equipment

● De-icing/anti-icing trucks

Most of today's equipment consists of trucks with a chassis on which the fluid tanks, pumps, heating and lifting components are installed.

Although centrifugal pumps are installed in older equipment, more modern equipment is fitted with cavity pumps or diaphragm pumps showing very low degradation of Type II and IV fluids.

Most of the trucks have an open basket from which the operator de-/anti-ices the aircraft. Closed cabins are also available, offering more comfort to the operator in a severe environment.

● Stationary equipment

Stationary de-/anti-icing facilities, currently available at a limited number of airports, consist of a gantry with spraying nozzles moving over the aircraft, similar in concept to a car wash.

The advantage of such a system is a fast and thorough treatment of the surface of the aircraft. As these systems can be operated by computers, working errors are practically excluded and consistent quality can be ensured.

The disadvantage, however, is the operational bottleneck. If only one system is available and de-/anti-icing is necessary, the takeoff capacity of the respective runway will be limited by the productivity of the gantry.

AIRCRAFT DE-ICING / ANTI-ICING ON THE GROUND

Please, bear in mind:

- Aircraft contamination endangers takeoff safety and must be avoided. The aircraft must be cleaned.
- To ensure that takeoff is performed with a clean aircraft, an external inspection has to be carried-out, bearing in mind that such phenomenon as clear-ice cannot be visually detected. Strict procedures and checks apply. In addition, responsibilities in accepting the aircraft status are clearly defined.
- If the aircraft is not clean prior to takeoff it has to be de-iced. De-icing procedures ensure that all the contaminants are removed from aircraft surfaces.
- If the outside conditions may lead to an accumulation of precipitation before takeoff, the aircraft must be anti-iced. Anti-icing procedures provide protection against the accumulation of contaminants during a limited timeframe, referred to as holdover time.
- The most important aspect of anti-icing procedures is the associated holdover-time. This describes the protected time period. The holdover time depends on the weather conditions (precipitation and OAT) and the type of fluids used to anti-ice the aircraft.
- Different types of fluids are available (Type I, II, and IV). They differ by their chemical compounds, their viscosity (capacity to adhere to the aircraft skin) and their thickness (capacity to absorb higher quantities of contaminants) thus providing variable holdover times.
- Published tables should be used as guidance only, as many parameters may influence their efficiency - *like severe weather conditions, high wind velocity, jet blast...*- and considerably shorten the protection time.

C. PERFORMANCE ON CONTAMINATED RUNWAYS



Operations on fluid contaminated runways raise numerous questions from operators. Airlines which often operate under cold or inclement conditions are generally concerned in obtaining a better understanding of the numerous factors influencing aircraft braking performance: On one hand, how to minimize the payload loss, and on the other, how to maintain a high level of safety.

It is evident that the braking performance is strongly affected by a slippery runway, however, one should also consider the loss in acceleration performance and in aircraft lateral controllability.

Once the different aspects of the impact of a contaminated runway are explained, it is quite necessary to review the operational information provided to the pilots. This information mainly contains some penalties (e.g. weight penalty or maximum crosswind reduction) but as well some indications on the runway condition provided as a «friction coefficient».

All this information should be readily understood so as to jeopardize neither airline safety nor airline economics.

C1 WHAT IS A CONTAMINATED RUNWAY?

A runway is considered contaminated when more than 25% of the surface is covered with a contaminant.

Contaminants are: water, slush, snow and ice.



The SPECIAL OPERATIONS chapter of the FCOM, provides the following definitions:

DEFINITIONS

DAMP	: A runway is damp when the surface is not dry, but when the water on it does not give it a shiny appearance.
WET	: A runway is considered as wet when the surface has a shiny appearance due to a thin layer of water. When this layer does not exceed 3 mm depth, there is no substantial risk of hydroplaning.
STANDING WATER	: Is caused by heavy rainfall and/or insufficient runway drainage with a depth of more than 3 mm.
SLUSH	: Is water saturated with snow which spatters when stepping firmly on it. It is encountered at temperatures around 5°C and its density is approximately 0.85 kg/liter (7.1 lb/US GAL).
WET SNOW	: Is a condition where, if compacted by hand, snow will stick together and tend to form a snowball. Its density is approximately 0.4 kg/liter (3.35 lb/US GAL).
DRY SNOW	: Is a condition where snow can be blown if loose, or if compacted by hand, will fall apart again upon release. Its density is approximately 0.2 kg/liter (1.7 lb/US GAL).
COMPACTED SNOW	: Is a condition where snow has been compressed (a typical friction coefficient is 0.2).
ICY	: Is a condition where the friction coefficient is 0.05 or below.

If the layer of contaminant on the runway is thin enough, the runway is not considered contaminated, but only wet.

FLEX takeoff is not allowed from a contaminated runway.

As far as performance determination is concerned, the following guidelines should be considered, as mentioned in the FCOM:

1. WET RUNWAY and EQUIVALENT

Equivalent of a wet runway is a runway covered with or less than :

- 2 mm (0.08 inch) slush
- 3 mm (0.12 inch) standing water
- 4 mm (0.16 inch) wet snow
- 15 mm (0.59 inch) dry snow

C2 AIRCRAFT BRAKING MEANS

Aircraft braking performance, in other words, aircraft «stopping capability», depends on many parameters. Aircraft deceleration is obtained by means of: Wheel brakes, aerodynamic drag, air brakes (spoilers) and thrust reversers.

C2.1 Wheel brakes

Brakes are the primary means of stopping an aircraft, particularly on a dry runway.

Deceleration of the aircraft is obtained via the creation of a friction force between the runway and the tire. This friction appears at the area of contact tire/runway. By applying the brakes, the wheel is slowed down and, therefore creates a force opposite to the aircraft motion. This force depends on the wheel speed and the load applied on the wheel.

● **Wheel load:**

A load must be placed on the wheel to increase the contact surface between the tire and the runway, and to create a braking/friction force.

There is no optimum on the load to be placed on the wheels. The greater the load, the higher the friction, the better the braking action.

The FRICTION COEFFICIENT is defined as the ratio of the maximum available tire friction force and the vertical load acting on a tire. This coefficient is named MU or μ .

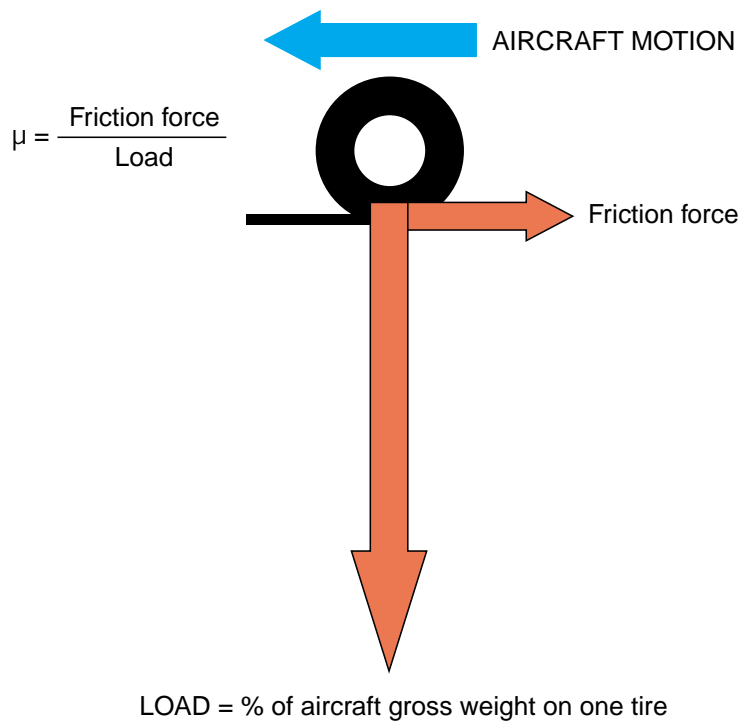

Figure C1

● **Wheel speed:**

The area of tire/runway contact has its own speed, which can vary between two extremes:

- Free rolling speed, which is equal to the aircraft speed.
- Lock-up speed, which is zero.

Any intermediate speed causes the tire to slip over the runway surface with a speed equal to: Aircraft speed - Speed of tire at point of contact. The slipping is often expressed in terms of percentage to the aircraft speed. Refer to Figure C2.

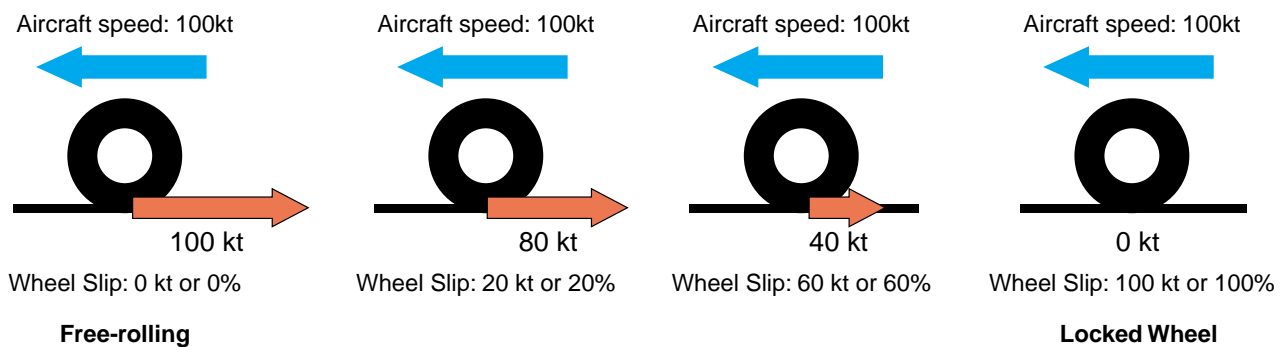

Figure C2

The friction force depends on the slip percentage. It is easily understood that a free-rolling wheel (in other words, zero % slip) does not resist aircraft motion, therefore does not create a friction force; so, in theory, there is no braking action.

It is a well-known fact that a locked-up wheel simply «skidding» over the runway has a bad braking performance. Hence, the advent of the so-called «anti-skid» systems on modern aircraft.

PRINCIPLE OF ANTI-SKID SYSTEM
Extracted from A320 FCOM, 1.32.30

The system compares the speed of each main gear wheel (given by a tachometer) with the speed of the aircraft (reference speed). When the speed of a wheel drops below 0.87 times the reference speed, the system orders brake releasing in order to maintain the brake slip at that value.

Somewhere in between these two extremes, lies the best braking performance. The following figure shows that the maximum friction force, leading to the maximum braking performance, is obtained for a slip ratio around 12%.

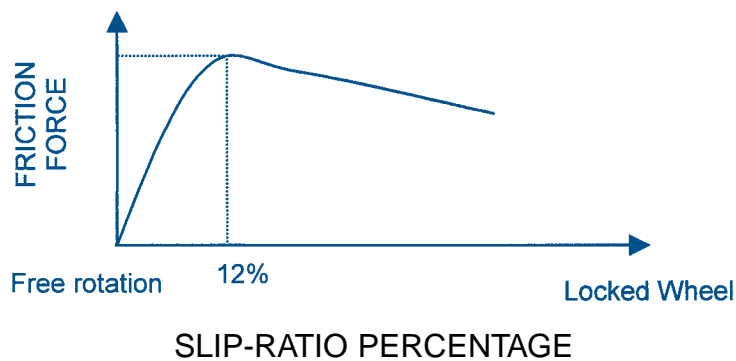

Figure C3

Tests have demonstrated that the friction force on a dry runway varies with the aircraft speed as per the following graph:

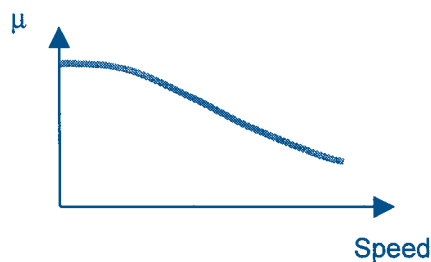

Figure C4

C2.2 Ground spoilers

Ground spoiler extension increases the aerodynamic drag and leads to deceleration. Extending the ground spoiler also significantly degrades the lift, thereby increasing the load on the wheels and brake efficiency.

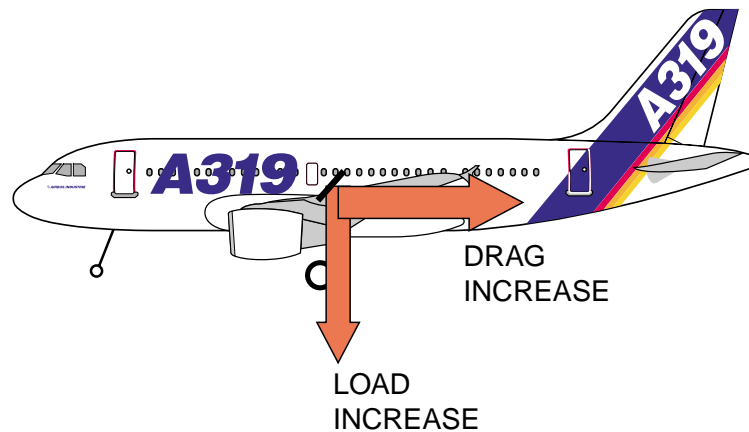

Figure C5

C2.3 Thrust reversers

Similar to ground spoiler extension, reversers create a force opposite to the aircraft's motion, inducing a significant decelerating force which is independent of the runway contaminant.

Regulations do not allow crediting reversers' effect on performance on a dry runway.

However, regulations presently allow crediting reversers' effect on takeoff performance for wet and contaminated runways.

The situation is a bit different for landing performance where regulations allow crediting the effect of reversers only for contaminated runways, and not for dry and wet runways.

Remark: This may lead to a performance-limited weight on a wet or contaminated runway being greater than the performance-limited weight on a dry runway. It is compulsory to restrict the performance-limited weight on a wet/contaminated runway to that of a dry runway.

As illustrated by the following graphs, reversers proportionally have a more significant effect on contaminated runways than on dry runways, since only low deceleration rates can be achieved on contaminated or slippery runways.

Example of energy distribution during landing stop - dry / wet runway

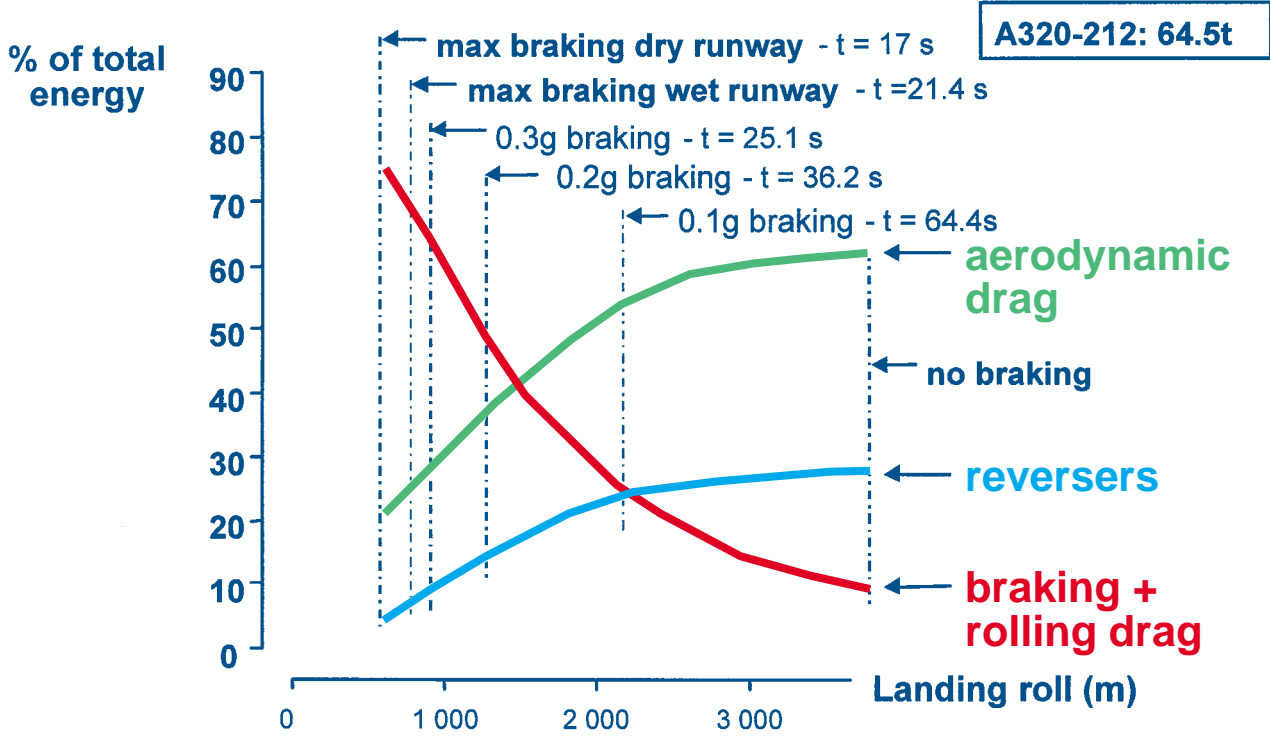

Figure C6

Example of energy distribution during landing stop - 1/4 inc water

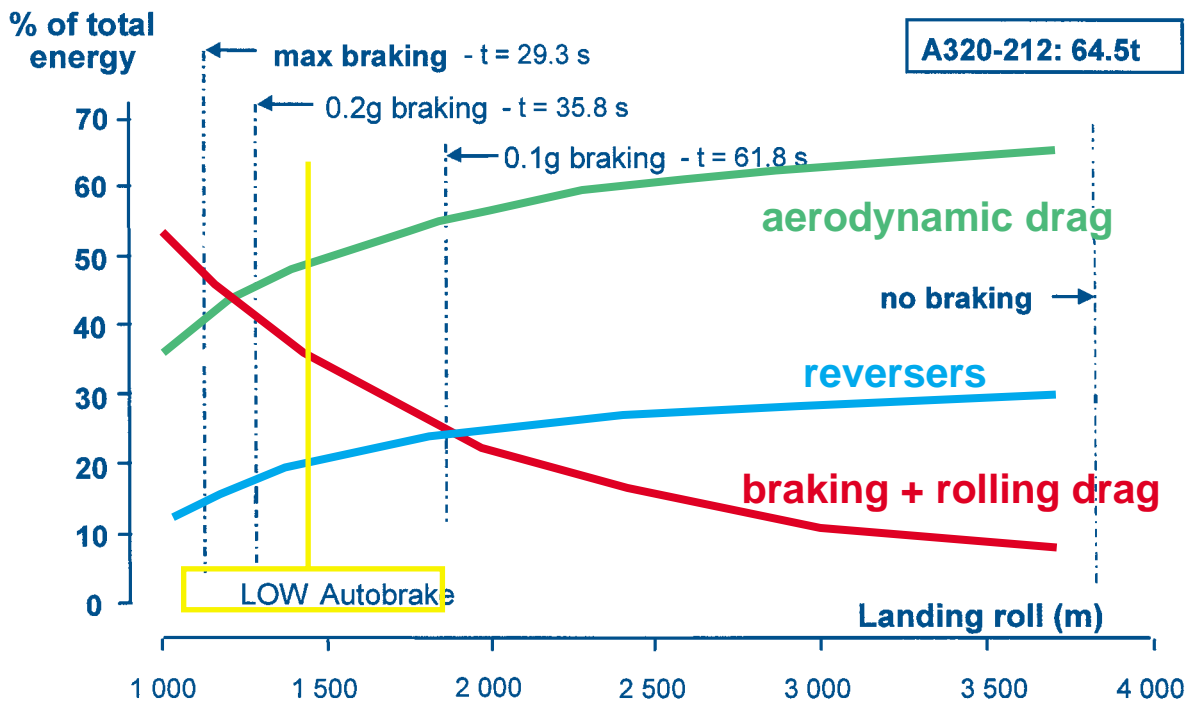

Figure C7

AIRCRAFT BRAKING MEANS

Please, bear in mind:

- There are three ways of decelerating an aircraft:

The primary way is with the wheel brakes. Wheel brakes stopping performance depends on the load applied on the wheels and on the slip ratio. The efficiency of the brakes can be improved by increasing the load on the wheels and by maintaining the slip ratio at its optimum (anti-skid system).

Secondary, ground spoiler decelerates the aircraft by increasing the drag and, most importantly, improves the brake efficiency by adding load on the wheels.

Thirdly, thrust reversers decelerate the aircraft by creating a force opposite to the aircraft's motion regardless of the runway's condition. The use of thrust reversers is indispensable on contaminated runways.



C3 BRAKING PERFORMANCE

The presence of contaminants on the runway surface affects the braking performance in various ways.

The first obvious consequence of the presence of contaminants between the tire and the runway surface is a loss of friction force, hence a reduced μ . If this phenomenon is quite natural to understand, it is difficult to convert it to useable figures. That is why the mathematical model is still evolving and is monitored by regulations.

The presence of a fluid contaminant like water or slush can also lead to a phenomenon known as aquaplaning or hydroplaning. In such a configuration, there is a loss of contact, therefore of friction, between the tire and the runway surface.

Fluid contaminants produce a lot of precipitation on the airframe and landing gears, causing additional drag.

Hard contaminants:
Compacted snow and ice
Decrease of friction forces



Figure C8

Fluid contaminants:
Water, slush and loose snow
Decrease of friction forces
+ precipitation drag
+ aquaplaning



Figure C9

C3.1 Reduction of the friction coefficient μ

Friction force reduction is due to the interaction of the contaminant with the tire and the runway surface. One can easily understand that this reduction depends directly on the contaminant. Let us review the μ reduction by contaminant.

C3.1.1 Wet runway

The following text is extracted from the ICAO Airport Services Manual, Part 2.

Quote

«Normal» wet friction is the condition where, due to the presence of water on a runway, the available friction coefficient is reduced below that available on the runway when it is dry. This is because water cannot be completely squeezed out from between the tire and the runway and, as a result, there is only partial contact with the runway by the tire. There is consequently a marked reduction in the force opposing the relative motion of the tire and runway because the remainder of the contacts is between tire and water.

To obtain a high coefficient of friction on a wet or water-covered runway, it is, therefore, necessary for the intervening water film to be displaced or broken through during the time each element of tire and runway are in contact. As the speed rises, the time of contact is reduced and there is less time for the process to be completed; thus, friction coefficient on wet surfaces tend to fall as the speed is raised, i.e. the conditions in effect become more slippery.

Unquote

In other words, we expect μ_{Wet} to be less than μ_{Dry} , and to diminish as speed increases.

Until recently, regulations stated that a good representation of the surface of the wet runway condition is obtained when considering μ_{Dry} divided by two.

For example, for the A300/A310/A320 and A321 aircraft $\mu_{\text{Wet}} = \mu_{\text{Dry}}/2$.

As of today, a new method has been developed accounting for:

- Tire wear state
- Type of runway
- Tire inflation pressure
- Anti-skid effect demonstrated through flight tests on wet runways.

In any cases, the braking friction coefficient diminishes (non-linearly) with the aircraft ground speed.

C3.1.2 Fluid contaminated runway: Water, slush and loose snow

The reason for friction force reduction on a runway contaminated by water or slush is similar to the one on a wet runway. The loss in friction is due to the presence of a contaminant film between the runway and the tire resulting in a reduced area of tire/runway dry contact.

As for the μ_{wet} , μ_{cont} is often derived from μ_{dry} . Again, until recently, regulations stated that $\mu_{\text{cont}} = \mu_{\text{dry}}/4$. This is applicable to A300/A310/A320/A321.

As for the wet condition, a new model has been developed to take into account tire wear state, type of runway, tire inflation pressure and anti-skid effect.

C3.1.3 Hard contaminated runway: Compacted snow and ice

These two types of contaminants differ from water and slush, as they are hard. The wheels just roll over it, as they do on a dry runway surface but with reduced friction forces.

As no rolling resistance or precipitant drag is involved, the amount of contaminant on the runway surface is of no consequence. Assuming an extreme and non-operational situation, it would be possible to takeoff from a runway covered with a high layer of hard compacted snow, while it would not be possible to takeoff from a runway covered with 10 inch of slush. One can easily imagine that the rolling resistance and precipitation drag would be way too important.

The model of the friction forces on a runway covered by compacted snow and icy runway as defined in the FCOM, leads to the following μ :

Compacted snow : $\mu = 0.2$
Icy runway : $\mu = 0.05$

C3.2 Precipitation drag

Regulation requires, e.g. AMJ 25x1591:

«During take-off acceleration, account should be taken of precipitation drag. During accelerate-stop deceleration and at landing, credit may be taken for precipitation drag.»



Precipitation drag is composed of the two following drags:

1/ Displacement drag

Drag produced by the displacement of the contaminant fluid from the path of the tire.

Increases with speed up to a value close to aquaplaning speed.

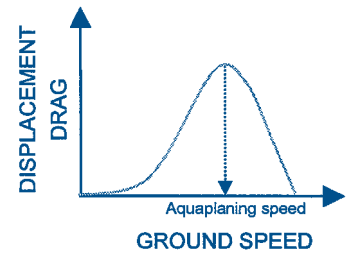

Figure C10

$$\text{Drag}_{\text{DISPLACEMENT}} = 0.5 \rho S_{\text{TIRE}} \text{GS}^2 C_D K$$

ρ is the density of the contaminant

S is the frontal area of tire in the contaminant

GS is the ground speed

C_D is the coefficient equal to 0.75 for water or slush

K is the coefficient for wheels (e.g. 1.6 for A320)

It is proportional to the density of the contaminant, to the frontal area of tire in the contaminant and to the geometry of the landing gear.

2/ Spray impingement drag

Additional drag produced by the spray thrown up by the wheels (mainly those of the nose gear) onto the fuselage.

C3.3 Aquaplaning

As previously explained, the presence of water on the runway creates an intervening water film between the tire and the runway leading to a reduction of the dry area. This phenomenon gets more critical at higher speeds, where the water cannot be squeezed out from between the tire and the runway. The aquaplaning is a situation where «the tires of the aircraft are, to a large extent, separated from the runway surface by a thin fluid film. Under these conditions, tire traction drops to almost negligible values and aircraft wheels braking as well as wheel steering for directional control is, therefore, virtually ineffective.» ICAO Airport Services Manual, Part 2.

Aquaplaning speed depends on the tire pressure and on the specific gravity of the contaminant (i.e. How dense is the contaminant).

$$V_{\text{AQUAPLANING}} \text{ (kt)} = 34 (\rho/\sigma)^{0.5}$$

With

ρ = tire pressure (kg/cm²)

σ = specific gravity of the contaminant

In other words, **the aquaplaning speed is a threshold from which friction forces diminish severely.**

BRAKING PERFORMANCE

Please, bear in mind:

- The presence of contaminants on the runway affects the performance by:
 1. A reduction of the friction forces (μ) between the tire and the runway surface,
 2. An additional drag due to contaminant spray impingement and contaminant displacement drag,
 3. Aquaplaning (hydroplaning) phenomenon.

- There is a clear distinction between the effect of fluid contaminants and hard contaminants:
 - Hard contaminants (compacted snow and ice) reduce the friction forces.
 - Fluid contaminants (water, slush, and loose snow) reduce the friction forces, create an additional drag and may lead to aquaplaning.

- To develop a model of the reduced μ according to the type of contaminant is a difficult issue. Until recently, regulations stated that μ_{wet} and μ_{cont} can be derived from the μ observed on a dry runway ($\mu_{\text{dry}}/2$ for wet runway, $\mu_{\text{dry}}/4$ for water and slush).

- Nevertheless, recent studies and tests have improved the model of μ for wet and contaminated runways, which are no longer derived from μ_{dry} . The certification of the most recent aircraft already incorporates these improvements.

C3.4 Correlation between reported μ and braking performance

C3.4.1 Information provided by the airport authorities

Airport authorities give measurements of a runway friction coefficient. The results are published via a standard form defined by the 1981 ICAO AGA meeting called SNOWTAM (See Figure C11).

SNOWTAM	Priority Indicator	ADDRESSES		
Date and Time of filing	Originator's Indicator	SNOW NOTAM ("S" SERIES) SERIAL NUMBER	NOTAM S	
AERODROME	A			
DATE/TIME OF OBSERVATION (<i>Time of completion of measurement in GMT</i>)	B	B		B
RUNWAY DESIGNATORS	C	C		C
CLEARED RUNWAY LENGTH, IF LESS THAN PUBLISHED LENGTH (<i>m</i>)	D	D		D
CLEARED RUNWAY WIDTH, IF LESS THAN PUBLISHED WIDTH (<i>m</i> ; <i>if offset left or right of centre line add "L" or "R"</i>)	E	E		E
DEPOSITS OVER TOTAL RUNWAY LENGTH (<i>Observed on each third of the runway, starting from threshold having the lower runway designation number</i>) NIL – CLEAR AND DRY 1 – DAMP 2 – WET or water patches 3 – RIME OR FROST COVERED (<i>depth normally less than 1 mm</i>) 4 – DRY SNOW 5 – WET SNOW 6 – SLUSH 7 – ICE 8 – COMPACTED OR ROLLED SNOW 9 – FROZEN RUTS OR RIDGES	F	F		F
MEAN DEPTH (<i>mm</i>) FOR EACH THIRD OF TOTAL RUNWAY LENGTH	G	G		G
BRAKING ACTION ON EACH THIRD OF RUNWAY AND MEASURING EQUIPMENT MEASURED OR CALCULATED COEFFICIENT or ESTIMATED BRAKING ACTION 0.40 and above GOOD – 5 0.39 to 0.36 MEDIUM/GOOD – 4 0.35 to 0.30 MEDIUM – 3 0.29 to 0.28 MEDIUM/POOR – 2 0.25 and below POOR – 1 9 – unreliable UNRELIABLE – 9 <i>(When quoting a measured coefficient use the observed two figures, followed by the abbreviation of the measuring equipment used. When quoting an estimate use single digits)</i>	H	H		H
CRITICAL SNOWBANKS (<i>If present, insert height (cm)/distance from the edge of runway (m) followed by "L", "R" or "LR" if applicable</i>)	J	J		J
RUNWAY LIGHTS (<i>If obscured, insert "YES" followed by "L", "R" or both "LR" if applicable</i>)	K	K		K
FURTHER CLEARANCE (<i>If planned insert length (m)/width (m) to be cleared or if to full dimensions, insert "TOTAL"</i>)	L	L		L
FURTHER CLEARANCE EXPECTED TO BE COMPLETED BY . . . (<i>GMT</i>)	M	M		M
TAXIWAY (<i>If no appropriate taxiway is available, insert "NO"</i>)	N	N		N
TAXIWAY SNOWBANKS (<i>If more than 60 cm, insert "YES" followed by distance apart, m</i>)	P	P		P
APRON (<i>If unusable insert "NO"</i>)	R			
NEXT PLANNED OBSERVATION/MEASUREMENT IS FOR . . . (<i>day/month/hour in GMT</i>)	S			
PLAIN LANGUAGE REMARKS (<i>Including contaminant coverage and other operationally significant information, e.g. sanding, deicing</i>)	T			

SIGNATURE OF ORIGINATOR (*not for transmission*)

Figure C11

A SNOWTAM contains:

- The type of contaminant,
- Mean depth for each third of total runway length,
- Estimated braking action,
- Reported μ .

Some operators have requested that Airbus provide contaminated runway performance data with Reported μ or Estimated Braking Action as an entry, in lieu of the type and depth of contaminant.

REPORTED MU	ESTIMATED BRAKING ACTION	
0.4 and above	GOOD	- 5
0.39 to 0.36	MEDIUM/GOOD	- 4
0.35 to 0.30	MEDIUM	- 3
0.29 to 0.26	MEDIUM/POOR	- 2
0.25 and below	POOR	- 1
9 - unreliable	UNRELIABLE	- 9

C3.4.2 Difficulties in assessing the effective μ

The two major problems introduced by the airport authorities evaluation of the runway characteristics are:

- The correlation between test devices, even though some correlation charts have been established.
- The correlation between measurements made with test devices or friction measuring vehicles and aircraft performance.

These measurements are made with a great variety of measuring vehicles, such as: Skidometer, Saab Friction Tester (SFT), MU-Meter, James Brake Decelerometer (JDB), Tapley meter, Diagonal Braked Vehicle (DBV).

Refer to ICAO, Airport Services Manual, Part 2 for further information on these measuring vehicles.

The main difficulty in assessing the braking action on a contaminated runway is that it does not depend solely on runway surface adherence characteristics.

What must be found is the resulting loss of friction due to the interaction tire/runway. Moreover, the resulting friction forces depend on the load, i.e. the aircraft weight, tire wear, tire pressure and anti-skid system efficiency.

In other words, to get a good assessment of the braking action of an A340 landing at 150,000 kg, 140 kt with tire pressure 240 PSI, the airport should use a similar spare A340... Quite difficult and pretty costly!

The only way out is to use some smaller vehicles. These vehicles operate at much lower speeds and weights than an aircraft. Then comes the problem of correlating the figures obtained from these measuring vehicles and the actual braking performance of an

aircraft. The adopted method was to conduct some tests with real aircraft and to compare the results with those obtained from measuring vehicles.

Results demonstrated poor correlation. For instance, when a Tapley meter reads 0.36, a MU-meter reads 0.4, a SFT reads 0.43, a JBD 12...

To date, scientists have been unsuccessful in providing the industry with reliable and universal values. Tests and studies are still in progress.

As it is quite difficult to correlate the measured μ with the actual μ , termed as effective μ , the measured μ is termed as «reported μ ».

In other words, one should not get confused between:

- 1/ Effective μ : The actual friction coefficient induced from the tire/runway surface interaction between a given aircraft and a given runway, for the conditions of the day.
- 2/ Reported μ : Friction coefficient measured by the measuring vehicle.

● Particularities of fluid contaminants

Moreover, the aircraft braking performance on a runway covered by a fluid contaminant (water, slush and loose snow) does not depend only on the friction coefficient μ .

As presented in chapters [C2.2](#) and [C2.3](#), the model of the aircraft braking performance (takeoff and landing) on a contaminated runway takes into account not only the reduction of a friction coefficient but also:

- The displacement drag
- The impingement drag

These two additional drags (required to be taken into account by regulations) require knowing **the type and depth of the contaminant**.

In other words, even assuming the advent of a new measuring friction device providing a reported μ equal to the effective μ , it would be impossible to provide takeoff and landing performance only as a function of the reported μ . Airbus Industrie would still require information regarding the depth of fluid contaminants.

C3.4.3 Data provided by Airbus Industrie

Please refer to [§ C6](#) for further details on contaminated runway performance provided by Airbus Industrie.

● Hard contaminants

For hard contaminants, namely compacted snow and ice, Airbus Industrie provides the aircraft performance independently of the amount of contaminants on the runway. Behind these terms are some effective μ . These two sets of data are certified.

- **Fluid contaminants**

Airbus Industrie provides takeoff and landing performance on a runway contaminated by a fluid contaminant (water, slush and loose snow) as a function of the depth of contaminants on the runway.

For instance, takeoff or landing charts are published for «1/4 inch slush», «1/2 inch slush», «1/4 inch water» and «1/2 inch water». For loose snow, a linear variation has been established with slush.

In other words, pilots cannot get the performance from reported μ or Braking Action.

Pilots need the **type and depth of contaminant** on the runway.

CORRELATION BETWEEN REPORTED μ AND BRAKING PERFORMANCE

Please, bear in mind:

- Airports release a friction coefficient derived from a measuring vehicle. This friction coefficient is termed as «reported μ ».
The actual friction coefficient, termed as «effective μ » is the result of the interaction tire/runway and depends on the tire pressure, tire wear, aircraft speed, aircraft weight and anti-skid system efficiency.
To date, **there is no way to establish a clear correlation between the «reported μ » and the «effective μ »**. There is even a poor correlation between the «reported μ » of the different measuring vehicles.

It is then very difficult to link the published performance on a contaminated runway to a «reported μ » only.

- The presence of **fluid contaminants** (water, slush and loose snow) on the runway surface **reduces the friction coefficient**, may lead to **aquaplaning** (also called hydroplaning) and creates an **additional drag**.
This additional drag is due to the precipitation of the contaminant onto the landing gear and the airframe, and to the displacement of the fluid from the path of the tire. Consequently, braking and accelerating performance are affected.
The impact on the accelerating performance leads to a limitation in the depth of the contaminant for takeoff.

Hard contaminants (compacted snow and ice) only affect the braking performance of the aircraft by a reduction of the **friction coefficient**.

- Airbus Industrie publishes the takeoff and landing performance according to the **type of contaminant**, and to the **depth** of fluid contaminants.

C4 AIRCRAFT DIRECTIONAL CONTROL

The previous section analyzes the impact of the reduction of the friction forces on aircraft braking performance. The reduction of friction forces also significantly reduces aircraft directional control.

One should also consider the effect of the crosswind component on a slippery runway.

C4.1 Influence of slip ratio

When a rolling wheel is yawed, the force on the wheel can be resolved in two directions: One in the direction of wheel motion, the other perpendicular to the motion.

The force in direction of the motion is the well-known braking force.

The force perpendicular to the motion is known as the «side-friction force» or «cornering force».

Steering capability is obtained via the cornering force.

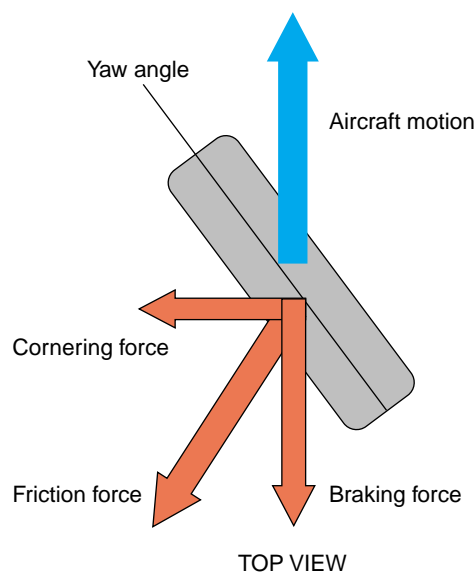

Figure C12

Maximum cornering effect is obtained from a free-rolling wheel, whereas a locked wheel produces zero cornering effect.

With respect to braking performance, we can recall that a free-rolling wheel produces no braking. In other words, maximum steering control is obtained when brakes are not applied. One realizes that there must be some compromise between cornering and braking.

The following figure illustrates this principle:

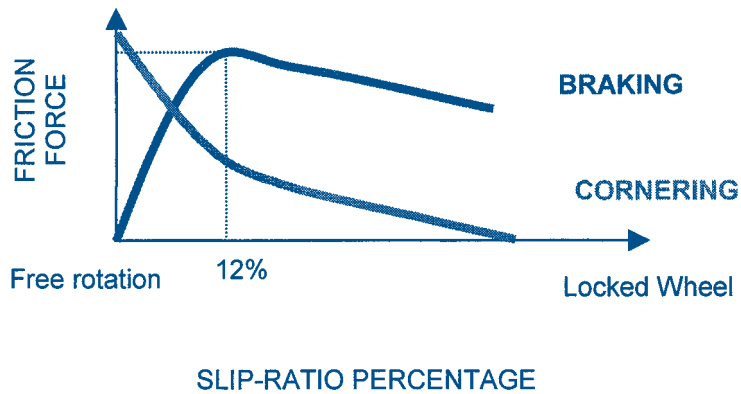

Figure C13

The above figure shows that when maximum braking efficiency is reached (i.e. 12% slippage), a significant part of the steering capability is lost. This is not a problem on a dry runway, where the total friction force, split in braking and cornering, is high enough. It may however be a problem on a slippery runway, where the total friction force is significantly reduced. In some critical situations, the pilot may have to choose between braking or controlling the aircraft. It may not have both at the same time.

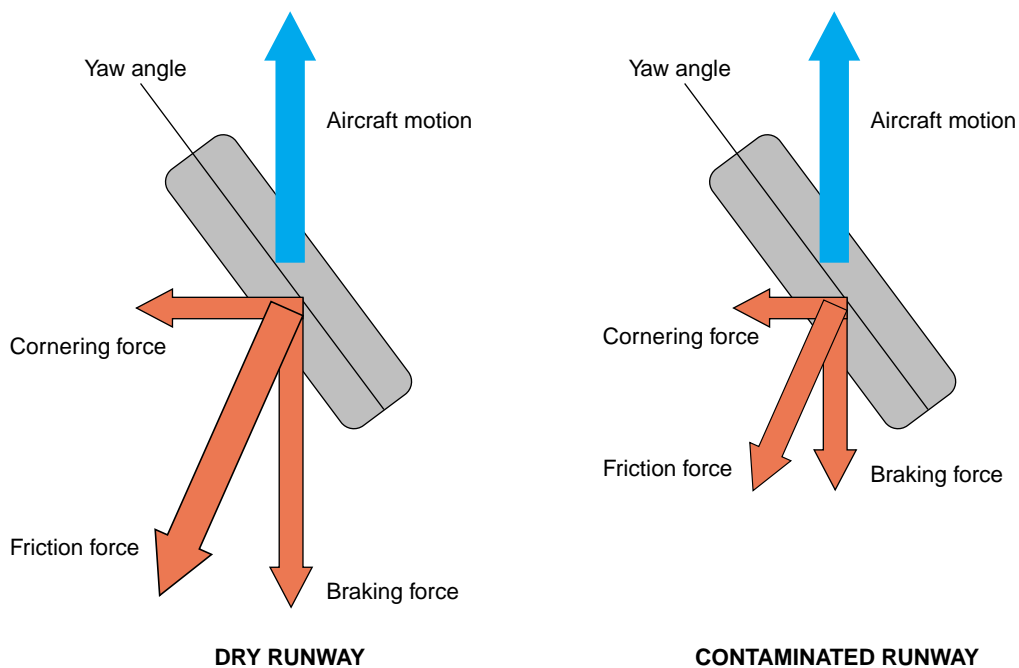

Figure C14

C4.2 Influence of wheel yaw angle

The cornering force also depends on the wheel yaw angle. The wheel yaw angle is defined as the angle between the wheel and its direction of motion. The cornering force increases with the yaw angle, however if the wheel is yawed too much, the cornering force rapidly decreases.

The wheel yaw angle providing the maximum cornering force depends on the runway condition and diminishes when the runway is very slippery. It is around 8° on a dry runway, 5° on a slippery runway and 3° on an icy runway.

C4.3 Ground controllability

During a crosswind landing, or aborted takeoff, cornering force is the primary way of maintaining the aircraft within the runway width.

In a crosswind situation, the aircraft crabs. That is, the aircraft's nose is not aligned with the runway centerline. [Refer to Figure C15.](#)

The wind component can be resolved into two directions: crosswind and head/ tail wind. Similarly, thrust reverse component is resolved both in a component parallel to the runway centerline, actually stopping the aircraft, and in a component perpendicular to the runway. For the purpose of this example, let's refer to it as «cross-reverse».

These two forces, crosswind and «cross-reverse» try to push the aircraft off the runway. The cornering forces induced by the main wheel and the nose wheel must balance this effect (as illustrated by [Figure C15](#)).

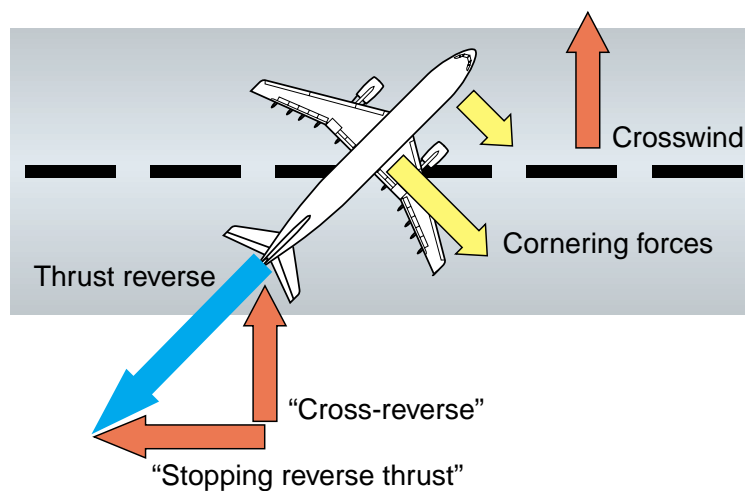

Figure C15

In such a situation, releasing the brakes would actually allow a greater cornering force to be developed, thus, regaining aircraft directional control.

When using autobrake, LOW mode provides more cornering force than MED mode.

AIRCRAFT DIRECTIONAL CONTROL

Please, bear in mind:

- When the wheel is yawed, a side-friction force appears. The total friction force is then divided into the braking force (component opposite to the aircraft motion) and the cornering force (side-friction).
The maximum cornering force (i.e. directional control) is obtained when the braking force is nil, while a maximum braking force means no cornering.
- The sharing between cornering and braking is dependent on the slip ratio, that is, on the anti-skid system.
- Cornering capability is usually not a problem on a dry runway, nevertheless when the total friction force is significantly reduced by the presence of a contaminant on the runway, in crosswind conditions, the pilot may have to choose between braking or controlling the aircraft.

C5 CROSSWIND

C5.1 Demonstrated crosswind

A demonstrated crosswind is given in the Aircraft Flight Manual (AFM). The words «**demonstrated crosswind**» have been intentionally selected to express that this is not necessarily the maximum crosswind that the aircraft is able to cope. It refers to the maximum crosswind that was **experienced** during the flight test campaign, and for which sufficient recorded data is available.

It is also intentional that **demonstrated crosswind is not given in the limitation section**, but is in the performance section of the AFM.

Demonstration of crosswind capability is made on dry or wet runways and it is usually considered that the given figures are equally applicable to dry or wet runways.

In fact the information given by the AFM is an indication of what was experienced during certification flight tests to provide guidance to operators for establishing their own limitations. FAR/JAR 25 requires this information to be given.

The maximum crosswind for automatic landing is defined in the limitation section of the AFM. In this case, it has to be understood as a limitation. That is the limitation of the system.

C5.2 Effect of runway contamination

It is a matter of fact that a poor runway friction coefficient will affect both braking action and the capability to sustain high crosswind components. Airbus Industrie issued recommendations based on calculations and operational experience in order to develop guidelines on the maximum crosswind for such runway conditions.

The FCOM - Special Operations - indicates the maximum recommended crosswinds related to estimated runway braking action. [Figure C16](#) below is an example provided in the A340 FCOM:

 A340 FLIGHT CREW OPERATING MANUAL	SPECIAL OPERATIONS	2.04.10	P 23
	FLUID CONTAMINATED RUNWAY	SEQ 001	REV 10

SPRAY PATTERN

There is a little chance of the engines ingesting fluid, which in any case should not jeopardize safety. The risk of ingestion is independent of the depth of the contaminant.

CROSSWIND

To optimize directional control during the low speed phase of the takeoff and landing roll and according to the reported braking action given by the control tower, it is not recommended to take off or to land with a crosswind component higher than :

Reported braking action	Reported runway friction coefficient	Maximum crosswind (kt)	Equivalent runway condition**
Good	≥ 0.4	27 *	1
Good/medium	0.39 to 0.36	27	1
Medium	0.35 to 0.3	20	2/3
Medium/poor	0.29 to 0.26	20	2/3
Poor	≤ 0.25	15	3/4
Unreliable		5	4/5

* This is the maximum crosswind demonstrated for dry and wet runway.

** Equivalent runway condition (only valid for maximum cross wind determination) :

1. Dry, damp or wet runway (less than 3 mm water depth)
2. Runway covered with slush
3. Runway covered with dry snow
4. Runway covered with standing water with risk of hydroplaning or wet snow
5. Icy runway or high risk of hydroplaning.

Figure C16

Caution:

Equivalent runway condition is only valid for **maximum crosswind determination**.
Do not use this equivalence for takeoff or landing performance determination.

CROSSWIND

Please, bear in mind:

- Airbus Industrie provides a maximum demonstrated crosswind for dry and wet runways. This value is not a limitation. This shows the maximum crosswind obtained during the flight test campaign at which the aircraft was actually landed. Operators have to use this information in order to establish their own limitation.
- The maximum crosswind for automatic landing is a limitation.
- Airbus Industrie provides as well some recommendations concerning maximum crosswind for contaminated runways. These conservative values have been established from calculations and operational experience.

C6 PERFORMANCE OPTIMIZATION AND DETERMINATION

C6.1 Performance Optimization

A contaminated runway impacts runway-related performance. The accelerate-go distance is increased due to the precipitation drag, and the accelerate-stop distance is increased due to the reduction in the friction forces.

The natural loss of payload, resulting from lower takeoff weight, can be minimized by different means. Optimization of flap setting, takeoff speeds and derated takeoff thrust are the main ways of limiting a loss in takeoff weight.

C6.1.1 Flap setting

Three different flap settings are proposed for takeoff. If the name of these flap/slat position used to be related to the actual deflection in degrees for the A300 and A310 models, it has been standardized to 1+F, 2 and 3 for the A320 family and A330/A340 models. Of course, the actual flap/slat deflection differs for each aircraft.

The influence of the flap setting on the takeoff performance is well-known. Low flap settings (e.g. Conf1+F) provide good climb performance (good lift to drag ratio) while the takeoff distance is longer (in other words bad runway performance).

A higher flap setting (e.g. Conf3) helps reduce the takeoff distance (improvement of the runway performance) at the expense of the climb performance (degradation of the lift to drag ratio).

Most of the time, a contaminated runway calls for higher flap setting. The accelerate-go and the accelerate-stop distances are then reduced. Yet, the presence of an obstacle may still require a minimum climb gradient calling for a lower flap setting. The right balance must be found.

The choice of the optimum flap setting is usually done manually. A quick comparison of the performance for the three different flap settings reveals which one is best.

The LPC (Less Paper in the Cockpit) allows for an automatic selection of the optimum configuration.

.

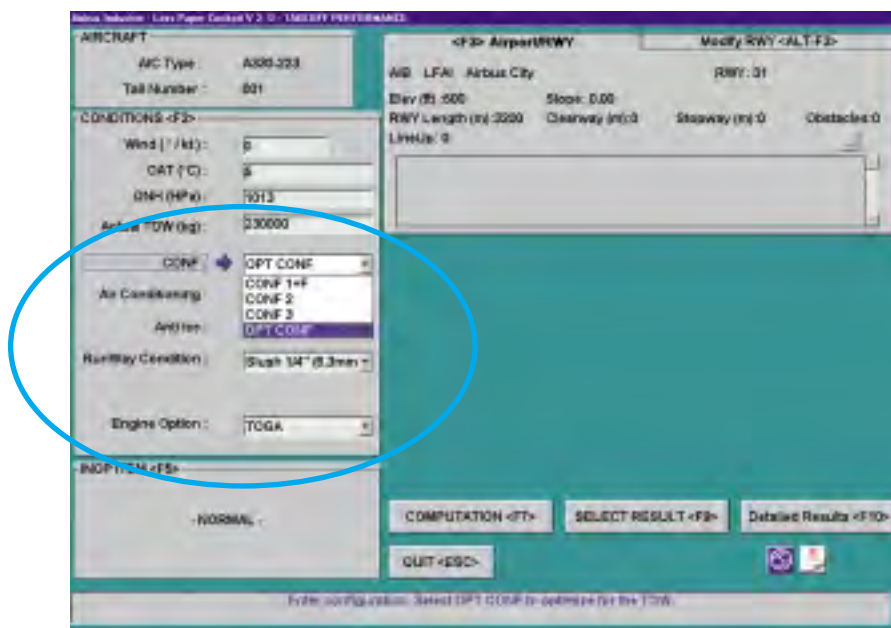

Figure C17 - LPC Screen

C6.1.2 Takeoff speeds

An improvement of runway performance can be achieved by reducing the takeoff speeds. A reduced V2 generates a reduced accelerate-go distance, while a reduced V1 generates a reduced accelerate-stop distance.

Regulations are helpful in this matter, as the 35ft screen-height is reduced to 15 ft should the runway be contaminated. For a given set of conditions, the V2 speed is lower at 15 ft than at 35 ft. In other words, the screen-height reduction allows for lower speeds.

Remark: Just like the effect of thrust reverse (See C2.3), the screen-height reduction may lead to a performance-limited weight on a wet or contaminated runway being greater than the performance-limited weight on a dry runway. It is compulsory to restrict the performance-limited weight on a wet/contaminated runway to that of a dry runway. Nevertheless, the determination of takeoff speeds must always account for the runway condition.

Moreover, Airbus takeoff charts take advantage of the so-called «optimized speeds». That is, speeds are increased, to meet a climb limitation or reduced to meet a runway limitation, accordingly.

In the case of a short and contaminated runway, the optimization process automatically selects lower speeds - yet, speeds are high enough to clear an obstacle, if any.

Though, the speed reduction gets its own limitation. The speeds must have some safety margins to the stall speed, minimum unstick speed (VMU) and minimum control speeds - VMCA (Minimum Control Speed in the Air) and VMCG (Minimum Control Speed on the Ground)

Regulations require the following:

$V1 \geq V1$ limited by VMCG

$VR \geq 1.05$ VMCA and $V2 \geq 1.1$ VMCA

$V2 \geq 1.13$ Vs1g for Fly-By-Wire aircraft, $V2 \geq 1.2$ Vs for other aircraft.

Remark: Other conditions exist, e.g. conditions on VMU.

The first condition affects the accelerate-stop distance.

The last two conditions affect the accelerate-go distance.

C6.1.3 Derated takeoff thrust

● **What is a derated thrust?**

Derated takeoff thrust is used to reduce the maximum thrust potentially developed by the engines. The maximum, or no derate, thrust is named TOGA (Takeoff and Go-Around).

The dual purpose of derated thrust is to reduce the takeoff thrust, as with flexible thrust, and to enable an increase in the takeoff weight.

Derate thrust and flexible thrust are quite often mistaken one for the other. It is beyond the scope of this brochure to detail the differences between flexible and derated thrust.

Airbus Industrie provides different derate levels. Each derate level is certified and associated with its own set of certified performance.

For instance, A340/A330 get derated 4%, 8%, 12%, 16%, 20% and 24%, respectively named D04, D08, D12, D16, D20 and D24.

The main difference between «Derated» thrust and «Flexible» thrust lies in the fact that **TOGA** (the full takeoff thrust) **can be recovered at any moment in the case of a flexible thrust**. This explains the name «flexible thrust»: It is reduced but can be increased at any time upon demand.

Whereas, in the case of **a derated thrust, it is not allowed to revert to TOGA** as long as speed is below F (Flaps retraction speed).

Another difference is that regulations do not allow the use of flexible takeoff thrust in the case of a contaminated runway while derated thrust is allowed. Airlines often operating in contaminated runway conditions can still save engine life with derated thrust.

Another advantage of derated thrust is that, in some situations, it allows an increase in takeoff weight.

● Consequence of derated thrust on takeoff weight.

The main consequence of derating the thrust developed by the engines is a reduction in the torque induced by the loss of the critical engine.

A lower torque signifies that it gets easier to control the aircraft and then a reduced VMCG is achieved.

Thus, each certified derated level comes with a certified VMCG.

The rudder is used to counter-balance the torque. Its efficiency is proportional to the aircraft speed. The minimum speed providing efficiency high enough to control safely the aircraft on the ground is VMCG (Minimum Control speed on the Ground).

A reduced VMCG allows for a reduced V1, which, in turn, allows for a reduced accelerate-stop distance (ASD).

In a situation where the takeoff weight is ASD-limited, a reduced thrust helps in reducing the ASD and therefore in increasing the takeoff weight.

Of course, while thrust reduction improves aircraft controllability, it degrades both climb performance and accelerate-go performance. Indeed, both of them require thrust. It is understood that excessive thrust reduction can be damaging for takeoff performance.

It must also be understood that a gain in takeoff weight is only noticeable when the performance is VMCG-limited. That is to say, typically on short and contaminated runways.

The following page shows three takeoff charts. The first one has been established for «NO DERATE», the second one for a derated level of 8% (D08) and the last one for a derated level of 24% (D24).

Step 1:

Check the red circles (#1).

Step 2:

Compare minimum speeds... Check the blue circles (#2).

The higher the derate level, the lower the minimum speeds.

Step 3:

Compare the MTOW... Check the green circles (#3).

MTOW D08 is greater than MTOW No Derate. The lower VMCs generate lower takeoff distances, allowing a higher takeoff weight.

MTOW D24 is less than MTOW No Derate. The thrust reduction is too significant. The lack of thrust helps controllability but reduces climb performance.

A340312 - JAA CFM56-5C3 engines		AIRBUS CITY		31	15.0.2 06-SEP-99 AA312B04 V 9
QNH 1013.25 HPA		Elevation 0 FT TORA 2500 M		0 obstacle	SLUSH 1/4"
Air cond. AC OFF		Isa temp 15 C TODA 2500 M			CONF 3
Anti-icing AI OFF		rwy slope 0.00% ASDA 2500 M		NO DERATE	
All reversers operating		FOR TRAINING ONLY			
OAT	WIND	HEADWIND		HEADWIND	
C	0 KT	10 KT		20 KT	
-5	235.7 3/9 126/41/49	245.8 3/9 130/45/51		252.4 3/9 133/47/53	
0	224.0 3/9 126/37/45	243.6 3/9 129/44/51		250.2 3/9 132/46/53	
5	217.2 3/9 126/34/43	241.6 3/9 128/43/50		248.0 3/9 132/45/52	
10	211.1 3/9 126/31/41	239.5 3/9 127/43/50		246.0 3/9 131/45/52	
15	202.5 3/9 127/29/39	234.5 3/9 126/41/48		243.6 3/9 129/44/51	
LIMITATION CODES: 1=1st segment 2=2nd segment 3=runway length 4=obstacles 5=tire speed 6=brake energy 7=max weight 8=final take-off 9=VMU		Tref (OAT) = 30 C Tmax (OAT) = 55 C		Min acc height = 450 FT Max acc alt = 3813 FT	
Min QNH alt = 430 FT Max QNH alt = 511 FT		Min V1/VR/V2 = 127/29/36 CHECK VMU LIMITATION Correct V1/VR/V2 = 0.2 KT/1000 K			

3

2

1

A340312 - JAA CFM56-5C3 engines		AIRBUS CITY		31	15.0.2 06-SEP-99 AA312B04 V 9
QNH 1013.25 HPA		Elevation 0 FT TORA 2500 M		0 obstacle	SLUSH 1/4"
Air cond. AC OFF		Isa temp 15 C TODA 2500 M			CONF 3
Anti-icing AI OFF		rwy slope 0.00% ASDA 2500 M		D08	
All reversers operating		FOR TRAINING ONLY			
OAT	WIND	HEADWIND		HEADWIND	
C	0 KT	10 KT		20 KT	
-5	230.1 3/9 125/40/47	236.2 3/9 129/43/49		242.3 3/9 133/45/51	
0	228.3 3/9 124/40/47	234.2 3/9 128/42/48		240.4 3/9 132/44/50	
5	226.3 3/9 123/39/46	232.2 3/9 127/41/48		238.4 3/9 131/43/49	
10	219.0 3/9 123/36/44	230.5 3/9 126/41/47		236.3 3/9 130/43/49	
15	211.4 3/9 123/33/41	228.4 3/9 125/40/47		234.2 3/9 129/42/48	
LIMITATION CODES: 1=1st segment 2=2nd segment 3=runway length 4=obstacles 5=tire speed 6=brake energy 7=max weight 8=final take-off 9=VMU		Tref (OAT) = 30 C Tmax (OAT) = 55 C		Min acc height = 450 FT Max acc alt = 3362 FT	
Min QNH alt = 430 FT Max QNH alt = 511 FT		Min V1/VR/V2 = 123/26/32 CHECK VMU LIMITATION Correct V1/VR/V2 = 0.2 KT/1000 K			

3

2

1

A340312 - JAA CFM56-5C3 engines		AIRBUS CITY		31	15.0.2 06-SEP-99 AA312B04 V 9
QNH 1013.25 HPA		Elevation 0 FT TORA 2500 M		0 obstacle	SLUSH 1/4"
Air cond. AC OFF		Isa temp 15 C TODA 2500 M			CONF 3
Anti-icing AI OFF		rwy slope 0.00% ASDA 2500 M		D24	
All reversers inoperative		FOR TRAINING ONLY			
OAT	WIND	HEADWIND		HEADWIND	
C	0 KT	10 KT		20 KT	
-5	208.2 3/9 120/35/40	212.9 3/9 123/36/42		217.6 3/9 127/38/43	
0	206.8 3/9 119/34/40	211.4 3/9 123/36/41		216.2 3/9 126/38/43	
5	205.3 3/9 118/33/39	209.9 3/9 122/35/41		214.7 3/9 125/37/42	
10	205.3 3/9 117/33/38	208.4 3/9 121/35/40		213.2 3/9 124/37/42	
15	202.3 3/9 117/32/38	206.9 3/9 120/34/40		211.6 3/9 124/36/41	
LIMITATION CODES: 1=1st segment 2=2nd segment 3=runway length 4=obstacles 5=tire speed 6=brake energy 7=max weight 8=final take-off 9=VMU		Tref (OAT) = 30 C Tmax (OAT) = 55 C		Min acc height = 450 FT Max acc alt = 2626 FT	
Min QNH alt = 430 FT Max QNH alt = 511 FT		Min V1/VR/V2 = 115/17/23 CHECK VMU LIMITATION Correct V1/VR/V2 = 0.2 KT/1000 K			

3

2

1

C6.2 Performance determination

Different methods for performance determination on a contaminated runway are available, depending on the operator system. The main difference is based on the medium: Paper or computer.

In order to determine the MTOW on a contaminated runway, an operator can choose to use:

- ❶ A takeoff chart established for a dry runway with optimized V2/VS ratio, then apply some conservative corrections from the FCOM, or
- ❷ A takeoff chart established for a dry runway, then apply the corrections for the runway conditions available on the chart, (*available only for A319, A321, A330 and A340 aircraft*) or,
- ❸ A takeoff chart established for a contaminated runway, or,
- ❹ The Less Paper in the Cockpit (LPC) program.

Of course, each operator has the flexibility of developing its own original method, nevertheless, these methods can generally be separated into the four main types mentioned above.

The following example illustrates the various methods and is based on these assumptions:

Aircraft	: A330-223
Airport	: Airbus City
Runway QFU	: 31
Runway condition	: Covered with 5 mm slush
Outside Air Temperature	: 5°C
No wind, Standard QNH CONF 2	

Example of method 1: Takeoff chart dry + FCOM corrections

A330223 - JAA		PW4168A engines		Airbus City		31	16.0.1 06-OCT-99 AB223B02 V13	
QNH 1013.25 HPA		Elevation 500 FT TORA 3200 M		Isa temp 14 C TODA 3200 M			DRY	
Air cond. Off		rwy slope 0.00%		ASDA 3200 M		0 obstacle	CONF 2	
Anti-icing Off		Do not use for operations						TOGA
All reversers operating								
No reversers on dry runway								
OAT C	TAILWIND -10 KT	WIND 0 KT	HEADWIND 10 KT	HEADWIND 20 KT				
-5	238.6 3/6 149/53/59	247.7 3/6 162/65/69	250.0 3/6 165/69/73	252.0 2/3 169/72/76				
0	237.5 3/6 148/52/58	246.8 3/6 160/64/68	249.2 3/6 164/67/72	251.2 2/3 168/71/75				
5	236.4 3/6 147/51/57	245.9 3/6 159/62/67	248.4 3/6 163/66/70	250.5 2/3 166/70/74				
10	235.4 3/6 146/50/56	244.9 3/6 158/61/66	247.7 3/6 162/65/69	249.8 3/6 165/68/72				
15	234.4 3/6 145/49/55	243.9 3/6 156/60/65	246.8 3/6 160/64/68	249.1 3/6 164/67/71				
20	233.4 3/6 143/48/54	243.0 3/6 155/59/64	245.9 3/6 159/63/67	248.3 3/6 163/66/70				
25	232.4 3/6 142/47/53	242.1 3/6 154/58/63	244.9 3/6 158/61/66	247.6 3/6 162/65/69				
30	230.7 3/6 142/46/52	240.4 3/6 153/57/62	243.3 3/6 157/60/65	245.9 3/6 161/64/68				
32	228.9 3/6 142/46/52	238.3 3/6 153/57/61	241.2 3/6 157/60/65	243.5 2/3 160/64/68				
34	226.9 3/6	236.2 3/6	238.6 3/6	240.9 2/3				

- Takeoff chart DRY-

A330 FLIGHT CREW OPERATING MANUAL	SPECIAL OPERATIONS		Z.04.10	P 5							
	FLUID CONTAMINATED RUNWAY		SEC 145	REV 11							
TAKEOFF FROM A 6.3 MM (1/4 INCH) SLUSH COVERED RUNWAY											
Determine maximum takeoff weight on dry runway. Apply the following weight decrement versus takeoff configuration and runway length to determine a corrected weight.											
RWY LENGTH (m)	2000 6500	2500 8000	3000 10000	3500 11500	4000 13000 and above	ΔWEIGHT(1000 kg)					
CONF 1 - F	25.0	29.0	28.0	27.0	22.0						
CONF 2	24.0	28.0	22.0	29.0	23.5						
CONF 3	28.0	17.0	23.0	25.0	29.8						
Enter the following tables with the corrected weight to determine MTOW. If the MTOW on dry runway is obstacle limited, check that MTOW is at least 21500 kg below MTCW on dry runway. If not, the MTOW on contaminated runway is MTOW on dry runway minus 21500 kg. Then determine takeoff speeds associated with actual TOW.											
CORRECTED WEIGHT (1000 kg) = 145 140 135 130 125.5 121 to 240											
MTCW (1000 kg) = 125 120 115 110 105.5 101 to 240											
1015 to 240											
SQA, TO CORRECTED WEIGHT											
ACTUAL WEIGHT (1000 kg)	<125	125	140	155	171.5	190	208	210	225	230	240
V _R (kt AS)	118	118	125	129	132	137	141	145	149	151	156
V _L (kt AS)	113	113	119	122	122	126	130	134	138	139	145
V _{LO} (kt AS)	112	112	112	113	113	116	117	118	124	124	130

- FCOM Correction -

- SPECIAL OPERATIONS chapter -

Step 1:

- Refer to the takeoff chart DRY.
- Enter in takeoff chart with wind and OAT.
- Read that MTOW on a DRY runway is 245 900 kg.

A330223 - JAA		PW4168A engines		Airbus City		31	16.0.1 06-OCT-99 AB223B02 V13	
QNH 1013.25 HPA		Elevation 500 FT TORA 3200 M		Isa temp 14 C TODA 3200 M			DRY	
Air cond. Off		rwy slope 0.00%		ASDA 3200 M		0 obstacle	CONF 2	
Anti-icing Off		Do not use for operations						TOGA
All reversers operating								
No reversers on dry runway								
OAT C	TAILWIND -10 KT	WIND 0 KT	HEADWIND 10 KT	HEADWIND 20 KT				
-5	238.6 3/6 149/53/59	247.7 3/6 162/65/69	250.0 3/6 165/69/73	252.0 2/3 169/72/76				
0	237.5 3/6 148/52/58	246.8 3/6 160/64/68	249.2 3/6 164/67/72	251.2 2/3 168/71/75				
5	236.4 3/6 147/51/57	245.9 3/6 159/62/67	248.4 3/6 163/66/70	250.5 2/3 166/70/74				
10	235.4 3/6 146/50/56	244.9 3/6 158/61/66	247.7 3/6 162/65/69	249.8 3/6 165/68/72				
15	234.4 3/6 145/49/55	243.9 3/6 156/60/65	246.8 3/6 160/64/68	249.1 3/6 164/67/71				
20	233.4 3/6 143/48/54	243.0 3/6 155/59/64	245.9 3/6 159/63/67	248.3 3/6 163/66/70				
25	232.4 3/6 142/47/53	242.1 3/6 154/58/63	244.9 3/6 158/61/66	247.6 3/6 162/65/69				
30	230.7 3/6 142/46/52	240.4 3/6 153/57/62	243.3 3/6 157/60/65	245.9 3/6 161/64/68				
32	228.9 3/6 142/46/52	238.3 3/6 153/57/61	241.2 3/6 157/60/65	243.5 2/3 160/64/68				
34	226.9 3/6	236.2 3/6	238.6 3/6	240.9 2/3				

Step 2:

- Refer to the FCOM corrections, SPECIAL OPERATIONS chapter.
- 5 mm of slush, use 6.3 mm (1/4 inch) slush data.
- Enter with airport runway length and configuration.

 A330 FLIGHT CREW OPERATING MANUAL	SPECIAL OPERATIONS		2.04.10	P 8
	FLUID CONTAMINATED RUNWAY		SEQ 145	REV 11

TAKEOFF FROM A 6.3 MM (1/4 INCH) SLUSH COVERED RUNWAY					
Determine maximum takeoff weight on dry runway. Apply the following weight decrement versus takeoff configuration and runway length to determine a corrected weight.					

RWY LENGTH (m) (ft)	2000 6500	2500 8000	3000 10000	3500 11500	4000 13000 and above	ΔWEIGHT(1000 kg)
CONF 1 + F	25.0	28.0	28.0	27.0	32.0	
CONF 2	24.0	24.0	22.0	29.0	33.5	
CONF 3	20.0	17.0	23.0	28.0	28.0	

Step 3:

- Interpolate for the runway length, (read from the takeoff chart header that runway length is 3200 M), read the weight penalty: 24 800 kg.

RWY LENGTH (m) (ft)	2000 6500	2500 8000	3000 10000	3500 11500	4000 13000 and above	ΔWEIGHT(1000 kg)
CONF 1 + F	25.0	28.0	28.0	27.0	32.0	
CONF 2	24.0	24.0	22.0	29.0	33.5	
CONF 3	20.0	17.0	23.0	28.0	28.0	

24.8

Step 4:

- Apply the penalty on the MTOW DRY, get the corrected weight.
- Corrected weight equals 245 900 kg minus 24 800 kg, i.e. 221 100 kg.

Step 5:

- Refer to the CONF 2 table.
- Read that MTOW SLUSH is equal to the corrected weight.

CONF 2	CORRECTED WEIGHT (1000 kg)	< 154.4	154.4	160	165	165 to 240								
	MTOW (1000 kg)	-	137.5	152	165	EQUAL TO CORRECTED WEIGHT								
	ACTUAL WEIGHT (1000 kg)	<137.5	137.5	150	160	165	170	180	190	200	210	220	230	240
	V2 (kt IAS)	117	117	122	126	128	130	133	137	141	144	148	151	154
	VR (kt IAS)	113	113	118	122	124	126	129	133	137	140	144	147	150
V1 (kt IAS)	113	113	113	113	113	115	118	122	126	129	133	136	139	

Step 6:

- Read the associated speeds. (Refer to the next higher weight, i.e. 230 t)

CONF 2	CORRECTED WEIGHT (1000 kg)	< 154.4	154.4	160	165	165 to 240								
	MTOW (1000 kg)	-	137.5	152	165	EQUAL TO CORRECTED WEIGHT								
	ACTUAL WEIGHT (1000 kg)	<137.5	137.5	150	160	165	170	180	190	200	210	220	230	240
	V2 (kt IAS)	117	117	122	126	128	130	133	137	141	144	148	151	154
	VR (kt IAS)	113	113	118	122	124	126	129	133	137	140	144	147	150
V1 (kt IAS)	113	113	113	113	113	115	118	122	126	129	133	136	139	

ANSWER METHOD 1:

MTOW SLUSH is 221 100 kg
V1 = 136, VR = 147 and V2 = 151.

Example of method 2: Takeoff chart dry + chart corrections

A330223 - JAA PW4000 engines		Airbus City		31		0 obstacle		DRY CONF 2 TOGA
QNH 1013.25 HPA Air cond. OFF Anti-icing ON All reversers operating No reversers on dry runway				Do not use for operations				
TAS		WIND		HEADWIND		HEADWIND		
KT		KT		KT		KT		
-5		-5		-5		-5		
1455209		1525069		1628873		1817276		
0		0		0		0		
1465209		1535069		1638873		1827276		
5		5		5		5		
1475197		1545087		1648875		1837376		
10		10		10		10		
1485094		1555096		1658938		1847676		
15		15		15		15		
1494961		1565085		1668978		1858176		
20		20		20		20		
1504804		1575064		1678975		1868876		
25		25		25		25		
1514601		1585063		1688978		1879676		
30		30		30		30		
1524461		1595062		1698975		1890576		
35		35		35		35		
1534361		1605061		1708975		1901576		
40		40		40		40		
1544361		1615061		1718975		1912676		
45		45		45		45		
1554461		1625061		1728975		1923876		
50		50		50		50		
1564661		1635061		1738975		1935176		
55		55		55		55		
1574961		1645061		1748975		1946576		
60		60		60		60		
1585361		1655061		1758975		1958076		
65		65		65		65		
1595861		1665061		1768975		1969676		
70		70		70		70		
1606461		1675061		1778975		1981376		
75		75		75		75		
1617161		1685061		1788975		1993176		
80		80		80		80		
1627961		1695061		1798975		2005076		
85		85		85		85		
1638861		1705061		1808975		2017076		
90		90		90		90		
1649861		1715061		1818975		2029176		
95		95		95		95		
1660961		1725061		1828975		2041376		
100		100		100		100		
1672161		1735061		1838975		2053676		

INFLUENCE OF RUNWAY CONDITION			
SLUSH	-20.9 ***	-23.2 ***	-24.3 ***
1/4"	-17/-10/-10 (+15) -44.8 ***	-16/-12/-12 (+15) -54.6 ***	-16/-12/-12 (+15) -58.7 ***
	-12/ 0/ 0	-9/ 0/ 0	-8/ 0/ 0

Step 1:

- Refer to the takeoff chart DRY.
- Enter in takeoff chart with wind and OAT.
- Read that MTOW on a DRY runway is 245 900 kg and associated speeds are 159/62/67

Step 2:

- Refer to the chart corrections.
- Read 23 200 kg and -16/-12/-12

ANSWER METHOD 2:

MTOW SLUSH is 245 900 kg - 23 200 kg equals 222 700 kg.

V1 = 159 - 16 = 141 kt

VR = 162 - 12 = 150 kt

V2 = 167 - 12 = 155 kt

A330223 - JAA		PW4000 engines		Airbus City		31		16.01.06-02.07.09 ASD2300 V11	
QNH 1013.25 HPA Air cond. OFF Anti-icing OFF All reversers operating No reversers on dry runway				Elevation 300 FT TORA 3200 M In temp 14 C TODA 3200 M Dry slope 0.00% ASDA 3200 M		0 obstacle		DRY CONF 2 TOGA	
GAT	TAILWIND -10 KT	WIND 0 KT	HEADWIND 10 KT	HEADWIND 20 KT					
-5	138.8 3/6 14953258	207.7 3/6 1628599	250.0 3/6 1658873	253.0 3/5 1697376					
0	137.3 3/6 14853258	206.8 3/6 1606188	249.2 3/6 1646372	251.2 3/5 1687179					
5	136.4 3/6 14753257	205.9 3/6 1596267	248.4 3/6 1636670	250.5 3/5 1667874					
10	135.4 3/6 14653256	205.0 3/6 1586366	247.7 3/6 1626969	249.8 3/6 1656672					
15	134.4 3/6 14554833	204.9 3/6 1584465	245.8 3/6 1606498	249.1 3/6 1646371					
20	133.4 3/6 14456414	203.0 3/6 1559864	245.9 3/6 1596397	248.3 3/6 1636670					
25	132.4 3/6 14358033	202.1 3/6 1549863	244.9 3/6 1586498	247.5 3/6 1626969					
30	130.7 3/6 14294633	200.4 3/6 1534762	243.3 3/6 1576698	245.9 3/6 1616698					
32	128.9 3/6 14294632	200.3 3/6 1534761	241.2 3/6 1576698	243.3 3/6 1606498					
34	126.9 3/6 14294632	200.2 3/6 1534761	238.6 3/6 1576698	240.9 3/6 1606498					
36	124.8 3/6 14294632	200.0 3/6 1534761	236.0 3/6 1576698	238.1 3/6 1606498					
38	122.7 3/6 14294632	201.0 3/6 1534960	233.4 3/6 1566997	235.4 3/6 1606498					
40	120.3 3/6 1444632	202.1 3/6 1534960	230.9 3/6 1566997	231.9 3/6 1596266					
42	118.3 3/6 1444632	203.9 3/6 1534999	228.1 3/6 1566997	229.8 3/6 1596266					
44	115.4 3/6 1444630	205.1 3/6 1534999	225.0 3/6 1566997	227.7 3/6 1596165					
46	108.8 3/6 1444630	215.3 3/6 1534998	217.0 3/6 1566997	218.7 3/6 1596164					
48	104.2 3/6 14346449	216.3 3/6 1534998	213.8 3/6 1566997	213.4 3/6 1596064					
50	100.0 3/6 14346448	205.1 3/6 1534997	206.6 3/6 1566998	209.9 3/6 1596063					
52	104.8 3/6 14244448	199.3 3/6 1534997	200.0 3/6 1566999	204.9 3/6 1596062					
54	100.3 3/6 14344447	194.0 3/6 1534996	195.0 3/6 1566999	198.8 3/6 1596062					
INFLUENCE OF RUNWAY CONDITION									
SLUSH	-20.9	-31.2	-34.3	-34.4					
1/4"	-11.8(-10)	-16.1(-12)	-16.1(-12)	-16.1(-12)					
3/4"	-10.5(-4.8)	-14.3(-14.6)	-14.3(-14.6)	-14.3(-14.6)					
1"	-9.0(0)	-9.0(0)	-9.0(0)	-9.0(0)					
INFLUENCE OF DELTA PRESSURE									
-10	-2.0	-3.1	-3.1	-3.1					
0	0(0)	0(0)	0(0)	0(0)					
10	0.5(0)	0.5(0)	0.5(0)	0.5(0)					
40	-1.0	-1.0	-1.0	-1.0					
100	-0.5(-1.0)	-0.5(-1.0)	-0.5(-1.0)	-0.5(-1.0)					
INFLUENCE OF ANTI-ICING ONLY BELOW 0°C									
Engine	-2.4	-3.1	-3.1	-3.1					
Wing	0(0)	0(0)	0(0)	0(0)					
INFLUENCE OF RUNWAY									
-23.2 ***									
-16.1(-12)									
(+15) -14.6 ***									
-9.0(0)									

Example of method 3: Takeoff chart contaminated

A330223 - JAA		PW4168A engines		Airbus City		31	16.01 (4-OCT-99)
QNH 1013.25 HPA		Elevation 300 FT TORA 3200 M		Do not use for operations			0 obstacle
Air cond. Off		Elev temp 14 C TODA 3200 M					SLUSH 1/4"
Anti-icing Off		run slope 0.00% ASDA 3200 M					CONF 2
All reversers operating							TOGA
OAT	TAILWIND	WIND		HEADWIND		HEADWIND	
C	-10 KT	0 KT		10 KT		20 KT	
-5	219.0 3/3 133/43/47	225.9 3/3 145/54/57	227.7 3/3 150/56/60	229.0 3/3 154/61/63			
0	218.2 3/3 130/42/46	225.5 3/3 144/53/56	227.3 3/3 148/51/59	228.3 3/3 152/60/62			
5	217.5 3/3 129/41/45	225.0 3/3 142/52/55	226.8 3/3 147/55/58	228.5 3/3 151/59/61			
10	216.6 3/3 128/40/44	224.5 3/3 141/51/54	226.4 3/3 145/54/57	228.1 3/3 150/58/60			

Step 1 AND ANSWER METHOD 3:

- Refer to the takeoff chart SLUSH 1/4".
- Enter in takeoff chart with wind and OAT.
- Read that MTOW on a SLUSHY runway is 225 000 kg, and speeds are V1 = 142, VR = 152 and V2 = 155

A330223 - JAA		PW4168A engines		Airbus City		31	16.01 (4-OCT-99)
QNH 1013.25 HPA		Elevation 300 FT TORA 3200 M		Do not use for operations			0 obstacle
Air cond. Off		Elev temp 14 C TODA 3200 M					SLUSH 1/4"
Anti-icing Off		run slope 0.00% ASDA 3200 M					CONF 2
All reversers operating							TOGA
OAT	TAILWIND	WIND		HEADWIND		HEADWIND	
C	-10 KT	0 KT		10 KT		20 KT	
-5	219.0 3/3 133/43/47	225.9 3/3 145/54/57	227.7 3/3 150/56/60	229.0 3/3 154/61/63			
0	218.2 3/3 130/42/46	225.5 3/3 144/53/56	227.3 3/3 148/51/59	228.3 3/3 152/60/62			
5	217.5 3/3 129/41/45	225.0 3/3 142/52/55	226.8 3/3 147/55/58	228.5 3/3 151/59/61			
10	216.6 3/3 128/40/44	224.5 3/3 141/51/54	226.4 3/3 145/54/57	228.1 3/3 150/58/60			

Example of method 4: Less Paper in the Cockpit

- 1 - Select Airport and runway.
- 2 - Select the conditions.

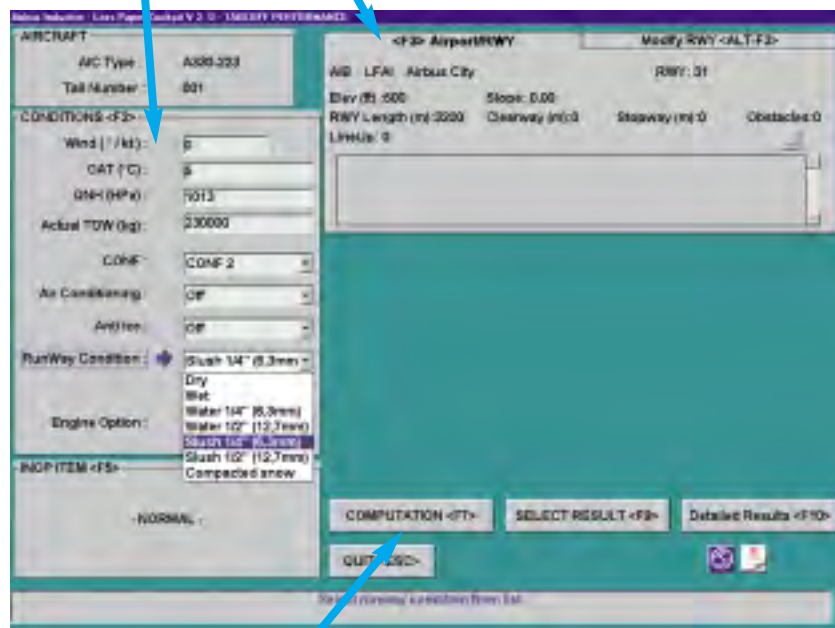

- 3- Run the computation.

4- Read the MTOW and speeds

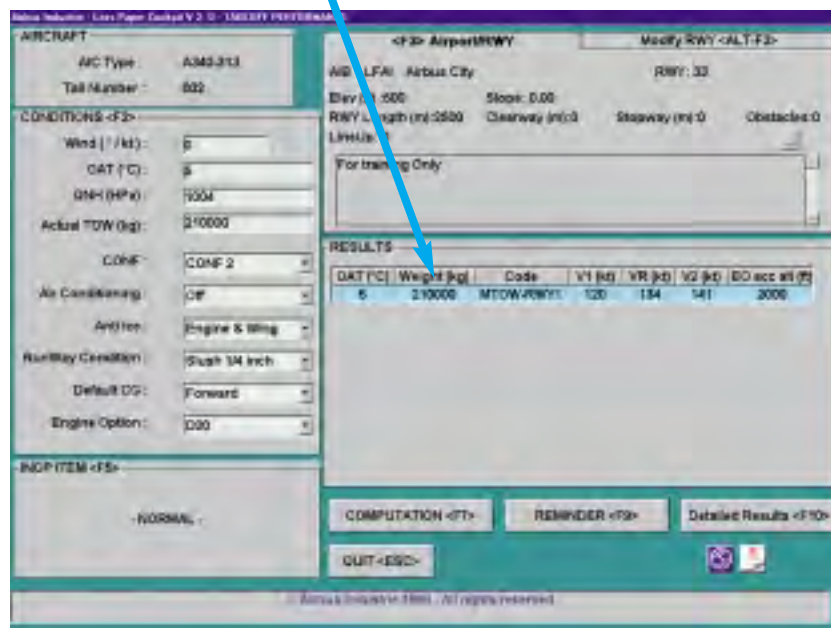

For the sake of simplicity the previous example does not cover:

- Takeoff speed determination,
- Flap setting optimization,
- Derate level optimization, and
- QNH, bleeds, MEL corrections.

The LPC program enables a very easy and quick determination of these parameters. The following example illustrates this:

ABYCRRAFT
 A/C Type: A320-31X
 Tail Number: 300

CONDITIONS (F2)
 Wind (1/MI): 0
 CAT (C): 5
 GPH (GPH): 7000
 Actual TOW (kg): 21000

CONF: OPT CONF
 Air Conditioning: CONF 14F
 Anti Ice: CONF 2
 Runway Condition: Slush 1M inch
 Default CG: Forward
 Engine Option: 000

ICUP (F2M) (F2)
 .NORMAL.

-(F2) Airport/RWY **Modify RWY (ALL) (F2)**
 A/E LPA Airport City RWY: 33
 Elev (ft) 500 Slope: 0.00
 RWY Length (m) 2000 Clearway (m) 0 Stopway (m) 0 Displaced 0
 LdaUp: 0
 Fuel tank(s) Only

COMPUTATION (F7) SELECT RESULT (F8) Detailed Results (F10)
 QUIT (ESC)

Light computation. Select OPT CONF to activate for PA T/W.

ABYCRRAFT
 A/C Type: A320-31X
 Tail Number: 300

CONDITIONS (F2)
 Wind (1/MI): 0
 CAT (C): 5
 GPH (GPH): 7000
 Actual TOW (kg): 21000

CONF: OPT CONF
 Air Conditioning: OFF
 Anti Ice: Engine & Wing
 Runway Condition: Slush 1M inch
 Default CG: Dry
 Engine Option: Standing water 1M in
 Standing water 1G in
 Slush 1M inch

ICUP (F2M) (F2)
 .NORMAL.

-(F2) Airport/RWY **Modify RWY (ALL) (F2)**
 A/E LPA Airport City RWY: 33
 Elev (ft) 500 Slope: 0.00
 RWY Length (m) 2000 Clearway (m) 0 Stopway (m) 0 Displaced 0
 LdaUp: 0
 Fuel tank(s) Only

COMPUTATION (F7) SELECT RESULT (F8) Detailed Results (F10)
 QUIT (ESC)

Select runway condition from list.

ABYCRRAFT
 A/C Type: A320-31X
 Tail Number: 300

CONDITIONS (F2)
 Wind (1/MI): 0
 CAT (C): 5
 GPH (GPH): 7000
 Actual TOW (kg): 21000

CONF: OPT CONF
 Air Conditioning: OFF
 Anti Ice: Engine & Wing
 Runway Condition: Slush 1M inch
 Default CG: Forward
 Engine Option: OPTIMUM DELAY

ICUP (F2M) (F2)
 .NORMAL.

-(F2) Airport/RWY **Modify RWY (ALL) (F2)**
 A/E LPA Airport City RWY: 33
 Elev (ft) 500 Slope: 0.00
 RWY Length (m) 2000 Clearway (m) 0 Stopway (m) 0 Displaced 0
 LdaUp: 0
 Fuel tank(s) Only

COMPUTATION (F7) SELECT RESULT (F8) Detailed Results (F10)
 QUIT (ESC)

Airbus Industrie A320 - AP 10270 1941941

INPUT SCREEN

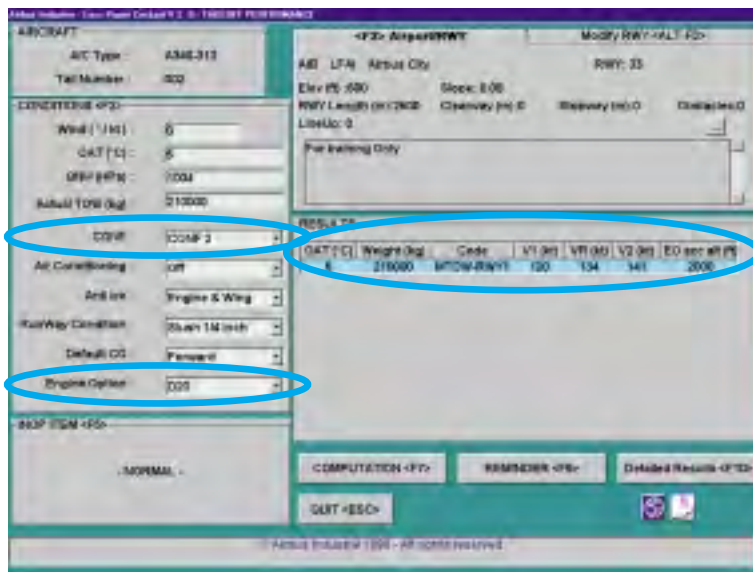

OUTPUT SCREEN

Performance determination summary

METHOD 1
Takeoff chart DRY
+FCOM correction

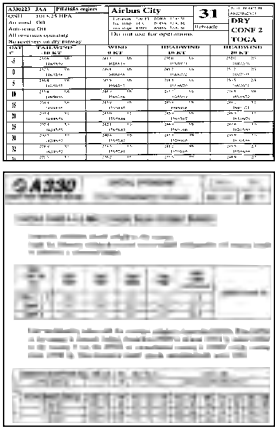

METHOD 2
Takeoff chart DRY
+Chart correction



METHOD 3
Takeoff chart
CONTAMINATED



METHOD 4
LPC program

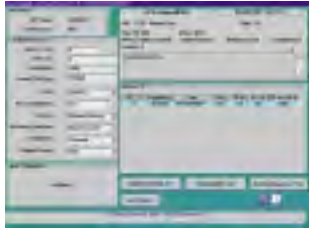

Precision scale

More conservative

More accurate

Difficulty of use



PERFORMANCE OPTIMIZATION AND DETERMINATION

Please, bear in mind:

- The presence of a contaminant on the runway leads to an increased accelerate-stop distance, as well as an increased accelerate-go distance (due to the precipitation drag). This results in a lower takeoff weight which can be significantly impacted when the runway is short.
- To minimize the loss, **flap setting and takeoff speeds should be optimized. Increasing the flap and slats extension results in better runway performance.** Both the accelerate-stop and accelerate-go distances are reduced. A short and contaminated runway naturally calls for a high flap setting. Nevertheless, one should bear in mind that the presence of an obstacle in the takeoff flight path could still require a lower flap setting as it provides better climb performance. **An optimum should be determined.** This optimum is usually found manually by a quick comparison of the different takeoff charts. The Airbus LPC (Less Paper in the Cockpit) enables an automatic computerized selection of the optimum flap.
- **The takeoff speeds**, namely V1, VR and V2 also **have a significant impact the takeoff performance.** High speeds generate good climb performance. The price to pay for obtaining high speeds is to spend a long time on the runway. Consequently, takeoff distances are increased and the runway performance is degraded. Thus, **a contaminated runway calls for lower speeds.** Once again, the presence of an obstacle may limit the speed reduction and **the right balance must be found.** Airbus performance programs, used to generate takeoff charts, take advantage of the so-called «speed optimization». **The process will always provide the optimum speeds.** In a situation where the runway is contaminated, that means as low as possible.
- The **FLEXIBLE THRUST** principle, used to save engine life by reducing the thrust to the necessary amount, **is not allowed when the runway is contaminated.** Operators can take advantage of the **DERATED THRUST.** The main difference between Flex thrust and Derated thrust is that, in the case of flexible thrust, it is allowed to recover maximum thrust (TOGA), whereas it is not allowed to recover maximum thrust at low speeds in the case of derated thrust.
- Moreover, the reduction of thrust makes it easier to control the aircraft should an engine fail (lesser torque). In other words, any time an engine is derated, the associated VMC (Minimum Control Speed) is reduced. This VMC reduction allows even lower operating speeds (V1, VR and V2) and, consequently, shorter takeoff distances. **In a situation where the performance is VMC limited, derating the engines can lead to a higher takeoff weight.**
- Different methods are proposed by Airbus Industrie to determine the performance on a contaminated runway. The methods differ by their medium (paper or electronic) and the level of conservatism and details they provide.

D. FUEL FREEZING LIMITATIONS



Di INTRODUCTION

On some particular routes, fuel freezing limitations may be a concern. When very low temperatures are expected, the dispatch or flight plan may be affected, and have economical implications. Some routes may not be flown under severe temperature conditions with any fuel type.

Similarly, when very low temperatures are encountered in flight, specific crew procedures may be necessary.

This chapter reviews various aspects associated with fuel freezing limitations.

D2 DIFFERENT TYPES OF FUEL

For commercial fuel requirements, (excluding North America, Russia and China), it is primarily the petroleum companies who dictate turbine fuel specifications, due to the variations in national specifications.

The Aviation Fuel Quality Requirements for Jointly Operated Systems is a petroleum industry standard which embodies the most stringent requirements of the UK DEF STAN 91/92 and USA ASTM D1655 fuel specifications to produce a kerosene fuel designated **JET A1**. It is known as the Joint Fuelling System Checklist (JFSCL) and is used by eleven major aviation fuel suppliers for virtually all civil aviation fuel supplies outside of North America, Russia and China.

All civil jet fuels in USA are manufactured to specifications defined by the American Society for Testing and Materials (ASTM). These civil fuels are designated by ASTM as D1655 **JET A** and **JET A1**, high and low freeze point kerosene type fuels, and D1655 **JET B**, wide cut low flash point type fuel. JET A is the principle fuel available in the USA. Jet fuels for use by the U.S. military services are controlled by an U.S. government specification and are given the prefix «**JP**».

International Air Transport Association (IATA) issued a «guideline jet fuel specification», the main purpose of which is to make specification comparison of jet fuels produced in various countries. The IATA Guidance Material presently defines suitable characteristics for four grades of aviation turbine fuels: **JET A**, **JET A1**, **TS-1** (kerosene-type fuels) and **JETB** (wide-cut fuel). These fuels meet the requirements of the following specifications:

- **JET A** ASTM D1655-98b (JETA)
- **JET A1** JFSCL (JET A1)
- **TS-1** GOST 10227-86 (TS-1)
- **JET B** CAN/CGSB-3.22.97 (Wide cut type)

The following fuel types are approved for use on Airbus Industrie aircraft. Some of them are approved for certain models only (refer to FCOM and AFM limitations).

● **Kerosene:**

This is an aviation turbine fuel type obtained from direct distillation.

Generally, the term «kerosene» is employed to describe a wide range of petroleum, defined only by a minimum flash point of 38°C and an end point of no more than 300°C.

- **Flash point** is the fuel temperature at which sufficient vapor forms at the surface of the liquid for the vapor to ignite in air when the flame is applied.
- **End point** or final point is the fuel temperature at which all of the liquid will distill over into vapor.

«**JET A1**» is by far the most frequently used fuel in civil aviation, (except in the USA and Russia), and has a maximum freezing point of -47°C and a mandatory requirement for a static dissipator additive.

«**JET A**» is similar to JET A1 but has a higher maximum freezing point of -40°C , with an option for a static dissipator additive. It is primarily available in the USA.

JP8 is similar to JET A1. It contains additives required by military users.

TS1 is a Russian fuel similar to JET A1. **RT** (Russian) and **TH** (Romanian) are other commonly available kerosenes in Eastern Europe. These three fuels can be used if the individual fuel batches are re-qualified to JET A1 or JET A fuel specification. Alternatively, specific flight test or in-service evaluation before approval on Airbus aircraft can be considered.

- **Wide-cut:**

These are obtained by mixing kerosene and aviation gasoline. They have a low flash point.

JET B is not widely used. It can be available in Canada and Alaska.

JP4 has not been produced since 1992 but can be found in military stock piles. It is being replaced by JP8 that provides more safety.

- **High flash point:**

JP5, which is obtained by direct distillation, has a flash point higher than 60°C and very low volatility characteristics.

It is almost exclusively used for naval operation aboard aircraft carriers.

This fuel is generally not found at civil airports.

D3 MINIMUM ALLOWED FUEL TEMPERATURE

D3.1 Published minimum fuel temperature

The minimum fuel temperature, published in the operational documentation, may be more restrictive than the certified aircraft environmental envelope. It includes two different limitations both linked to engine operation: Fuel freezing point limitation, and Fuel heat management system limitation.

a) Fuel freezing point limitation

This limitation provides an operating margin to prohibit operations under fuel temperature conditions that could result in the precipitation of waxy products in the fuel. The presence of wax crystals in the fuel is undesirable because of the risk of fuel lines and filters becoming blocked, with consequential effects on engine operation (instability, power loss or flame-out).

The resulting limitation varies with the freezing point of the fuel being used.

Aside from this, engines have a fuel warming (oil cooling) system at their inlet. Because of the architecture of this system and the fact that the fuel inlet hardware varies from one engine type to another, the specification of what fuel temperature is acceptable at the inlet of the engine varies from one engine type to the other.

Therefore, engine manufacturers sometime require a temperature margin to fuel freezing point to guarantee correct operation.

The engine manufacturer's margins relative to the fuel freezing point are as follows:

- Pratt and Whitney : 0°C
- Rolls Royce : 0°C
- General Electric : 3°C
- IAE : 4°C
- CFM (A319/A320/A321) : 4°C
- CFM (A340) : 5°C

b) Fuel heat management system limitation

This limitation reflects the engine capability to warm-up a given water-saturated fuel flow to such a point that no accumulation of ice crystals may clog the fuel filter.

Such a limitation does not appear in the documentation for some engine types when outside the environmental envelope.

When applicable, the resulting limitation is a fixed temperature below which, flight (or takeoff only, if high fuel flows only cannot be warmed-up enough) is not permitted.

The most restrictive of the two limitations above (a and b) should be considered.

Note: The fuel anti-icing additives authorized by engine manufacturers decrease the freezing temperature of the water contained in the fuel (decrease the fuel heat management system temperature limitation), but have no effect on the fuel freezing temperature itself.

Furthermore, an additional 2°C margin for temperature indication inaccuracy has been requested by airworthiness authorities for A300/A310 aircraft.

Therefore, the minimum fuel temperature should be:

**FUEL FREEZING POINT
+ ENGINE MANUFACTURER MARGIN
(+ 2°C for A300/A310)**

The fuel freezing point to be considered is the **actual** fuel freezing point.

If the actual freezing point of the fuel being used is unknown, the minimum fuel **specification values** as indicated below should be used as authorized by the AFM/FCOM.

JET A	JP5	JET A1/JP8	RT/TS-1	JET B	TH	JP4
-40°C	-46°C	-47°C	-50°C	-50°C	-53°C	-58°C

Note 1: The freezing point, as defined in the ASTM test methods, is the temperature at which the visible solid fuel particles (waxing) disappear on warming dry fuel (water free) which has previously been chilled until crystal appear. However, for Russian and some other Eastern European fuels (RT, TS-1, TH) using the GOST test method, the fuel freezing point is equal to the temperature at which solid fuel particles first appear, (waxing) when cooling dry fuel. This means that Russian fuels with a declared freezing point of -50°C under GOST specification would have an equivalent freezing point of -47°C when tested to ASTM method. Hence JET A1, RT and TS-1 normally have the same fuel freezing temperature.

Note 2: The freezing point temperature for Russian RT and TS-1 fuels is dependent upon the region. RT and TS-1 fuels have maximum fuel freezing temperatures of -50°C for all areas where the ground level air temperature is not below -30°C during 24 hours before departure. For areas where the ground level air temperature is below -30°C during 24 hours before departure then upon customer request the following fuel freezing temperature specification applies RT: -55°C and TS-1: -60°C.

As far as the fuel freezing point limitation is concerned and depending on the aircraft type, the following applies:

D3.2 A300/A310

- Fuel can be directly fed into the engines from CTR, INR or OTR tanks. The OTR tank being the coldest tank due to its low thermal inertia, a single temperature sensor (when fitted) is located in the left outer tank.

Flight tests showed that in thermally stabilized conditions, the fuel temperature in the inner tanks is always **at least 3°C above the outer tank temperature**.

Engine fuel feeding from the OTR tanks is, therefore, the limiting criteria.

Airworthiness authorities agree that pilots may take benefit of this 3°C difference when fuel is fed from a tank other than the outer tanks.

Therefore, for A300/A310 aircraft, the minimum allowable fuel temperature in flight is:

- When fuel is fed from **OUTR** tanks:
ACTUAL FUEL FREEZING POINT + ENGINE MARGIN + 2°C
- When fuel is fed from **CTR** or **INR** tanks:
ACTUAL FUEL FREEZING POINT + ENGINE MARGIN + 2°C - 3°C

- For takeoff, it is assumed that the fuel temperature is the same in all tanks and therefore the same limitation as when flying with fuel fed from the OTR tanks applies (i.e. without taking benefit of the 3°C difference between OTR and INR in flight).

- For A300/A310 aircraft **without fuel temperature indication**, the above limitations also apply; the tank fuel temperature being assessed through a correlation with the Total Air Temperature (TAT).

It has been evidenced by development tests and confirmed by additional records obtained in revenue service, that after thermal stabilization, the outer tank fuel temperature is within 2°C of the TAT. (See figure D1)

This offset has the same value (2°C) as the expectable error of the fuel temperature indication system when installed as mentioned above.

Thus the 2°C margin is also requested when TAT is used in place of the actual fuel temperature.

Figure D2, illustrates the A300/A310 outer tank fuel temperature response to TAT variations.

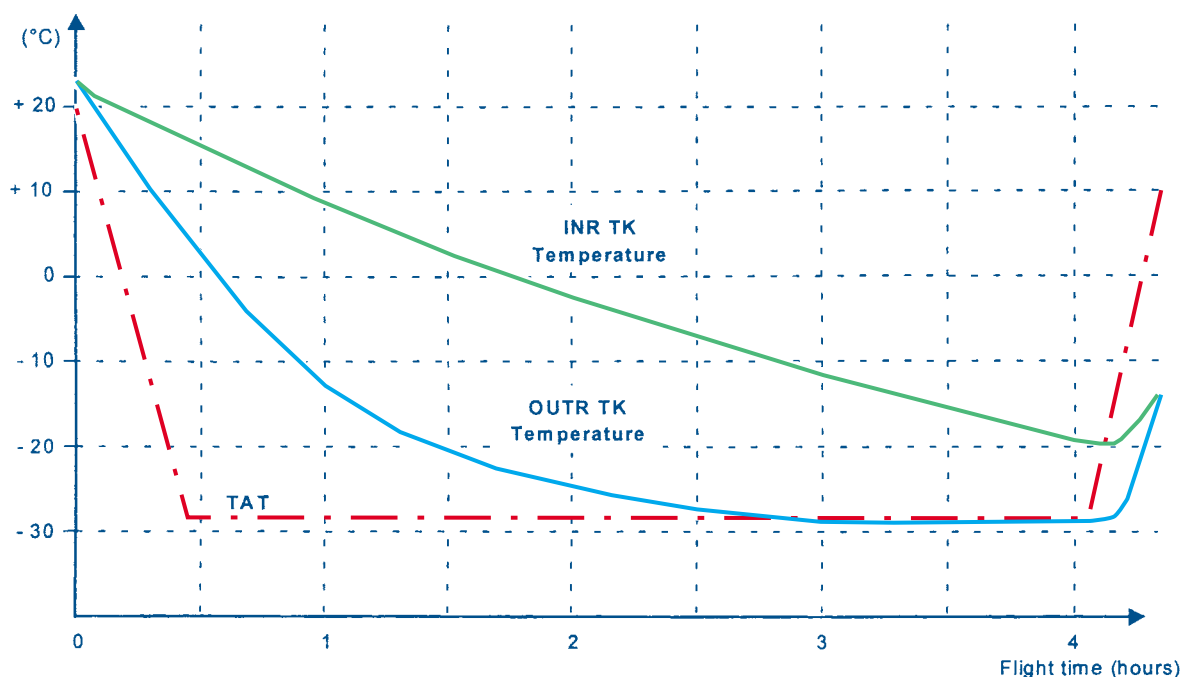

Figure D1 - A310 Outer and inner tank fuel temperature response to TAT variations (development tests data)

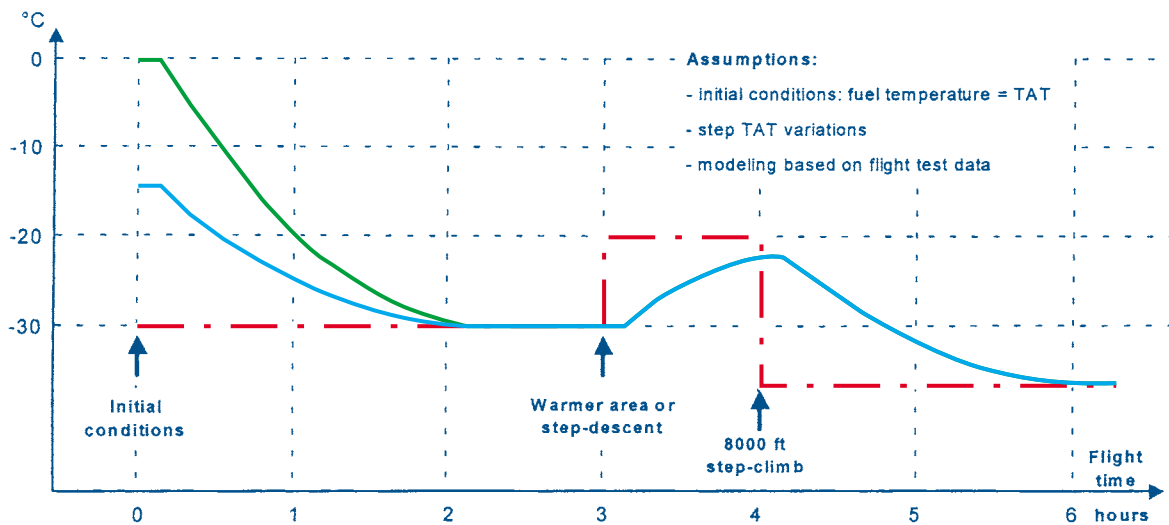

Figure D2 - A300/A310 outer tank fuel temperature response to TAT variations

The following remarks should be highlighted (with respect to the A300 and A310):

- Whatever the initial tank fuel temperature and the magnitude of the TAT change, the tank fuel temperature reaches a complete thermal stabilization (within 2°C of TAT) typically after **2 to 3 hours**.
- The outer tank fuel temperature response to any significant change in the TAT typically features a 10-minute time lag.
- Prior to thermal stabilization, the TAT is a conservative indicator of the actual OTR tank temperature.
However in case of TAT increase - warmer air or step descent - the TAT/OUTR tank relationship is reversed.
In such a case, reference should be made to the coldest TAT previously observed (i.e. prior to TAT increase) in order to recover a conservative indicator of the actual OTR tank fuel temperature.
- An extended environmental envelope has been approved only for A300-600 and A310 aircraft **fitted with the fuel temperature indication** system ([figure D3](#)).
However, the full benefit of this extended envelope may be limited by the tank fuel temperature limitation.

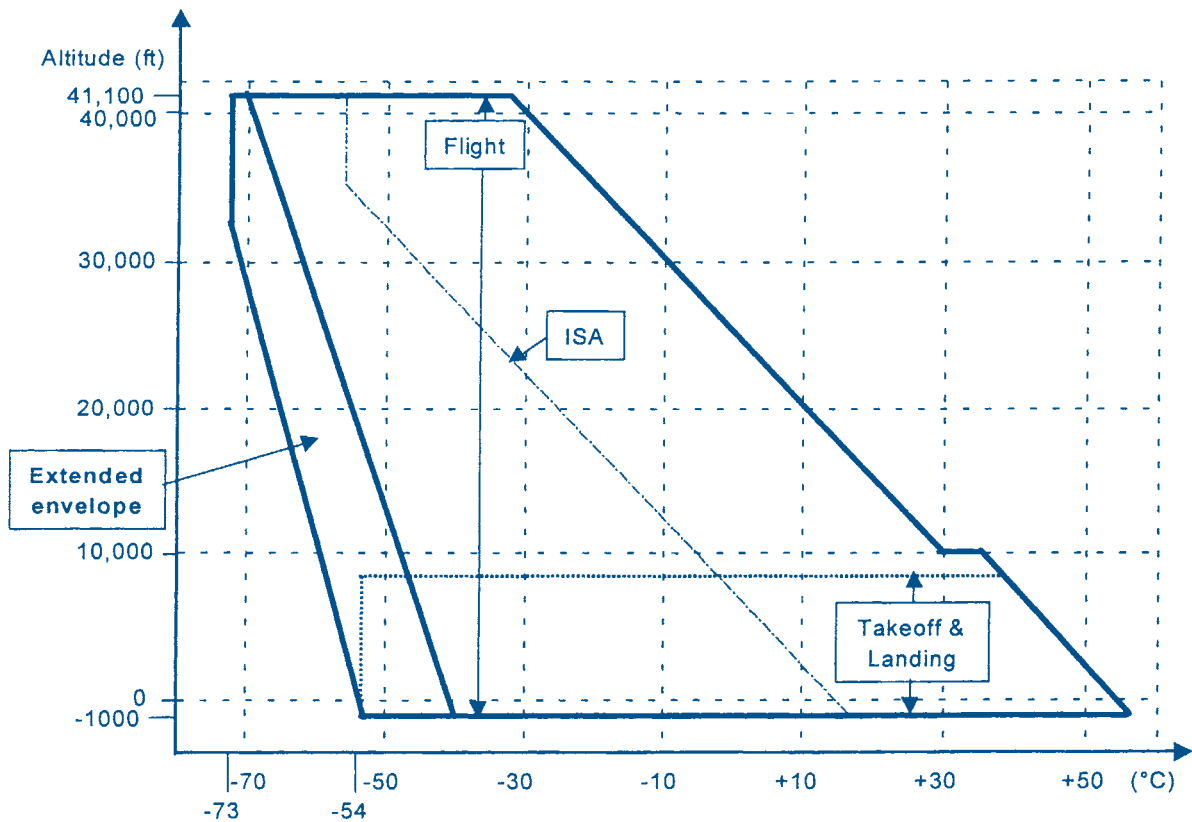

Figure D3 - A310 extended environmental envelope

D3.3 A319/A320/A321

A fuel temperature sensor is installed in each outer and inner cell on the A319 and A320, and in each wing tank on the A321.

Different means are provided to avoid flying below minimum allowed fuel temperature:

- The Flight Manual mentions:
«When using JET A:
If TAT reaches -34°C , call ECAM fuel page and monitor that fuel temperature remains higher than -36°C .»
- An ECAM advisory is activated as soon as fuel temperature in any tank reaches -40°C
- An ECAM warning «FUEL OUTER / INNER (FUEL WING on A321) TK LO TEMP» is activated when fuel temperature in any tank reaches -45°C .
On ground before takeoff, this warning is associated with «DELAY T.O» message.

D3.4 A330/A340

A fuel temperature sensor is installed in each inner tank, in the trim tank and in the LH outer tank.

The ECAM displays the appropriate information according to the actual fuel temperature.

- If **INR TK fuel temperature < -35°C** (-37°C on A330) (-40°C for OUTFR TK or TRIM TK) the message «**IF JET A**» appears together with the appropriate procedure (delay takeoff if on ground or transfer fuel in flight).
- This caution is automatically recalled if **INR TK fuel temperature < -42°C** (-44°C on A330) (-47°C for OUTFR TK or TRIM TK). In this case «IF JET A» is not displayed.
- For both cases occurring in flight the ECAM also displays the following message:

«IF NECESSARY:
TAT INCREASE»

The first occurrence copes with JET A fuel which may have a freezing point up to -40°C. It complies with the 5°C margin requested for CFM engine on A340, and consequently with the 3°C (GE) and 0°C (PW and RR) on A330.

The second occurrence deals with JET A1 fuel freezing point (-47°C) and all other fuels having a lower freezing point and also complies with all engine manufacturers margins.

D4 MAXIMUM ACCEPTABLE FUEL FREEZING POINT

D4.1 Wish expressed for JET A1 freezing point relaxation

The limit on freezing point in the jet fuel specification is one of the major constraining factors as to how much jet fuel can be made from a particular crude oil. In other words, **the lower the freezing point, the lower the yield of fuel obtainable from the crude oil.**

This was highlighted during the second «oil shock» in 1979 when, to increase fuel availability, a relaxation of the JET A1 specification freezing point from the (then) limit of -50°C maximum was proposed.

Analysis of in-flight fuel temperatures by airlines concluded that a freezing point of -47°C would not compromise flight safety and the fuel specification limit was changed to this level in 1980.

Again, at the beginning of the 90's, when the fuel prices increased prior to the Gulf war, certain IATA members expressed a wish for the freezing point of JET A1 (-47°C maximum) to be relaxed to the JET A level (-40°C maximum), hoping that this would make more kerosene available from crude oil and cause the fuel price to fall.

According to fuel suppliers, such a relaxation could potentially increase jet fuel production by about 8%. Nevertheless, they all agree that, for various reasons, this is a theoretical figure that cannot be guaranteed and that would not necessarily make jet fuel cheaper.

Consequently, a change in freezing point should be based on technical requirements and not solely economic factors.

As a result, IATA member airlines were asked to monitor in-flight fuel temperatures during long flights.

The result of this survey led, in 1992, to a general consensus that a change in the fuel freezing point specification from -47°C to -40°C is not acceptable due to flight safety and economic operation aspects which would be adversely affected by such a change.

D4.2 Fuel temperature encountered in flight

This survey highlighted that many international routes could not be flown using JET A without running into problems.

Figure D4 shows the result of a survey performed in wintertime by an A310 operator on Trans-Siberian routes, which covers one of the most severe low temperature sectors.

These graphs prove that JET A (having a freezing point of -40°C) is inadequate on such routes.

SVO - NRT (FL 332 / 364 - 14 flights)

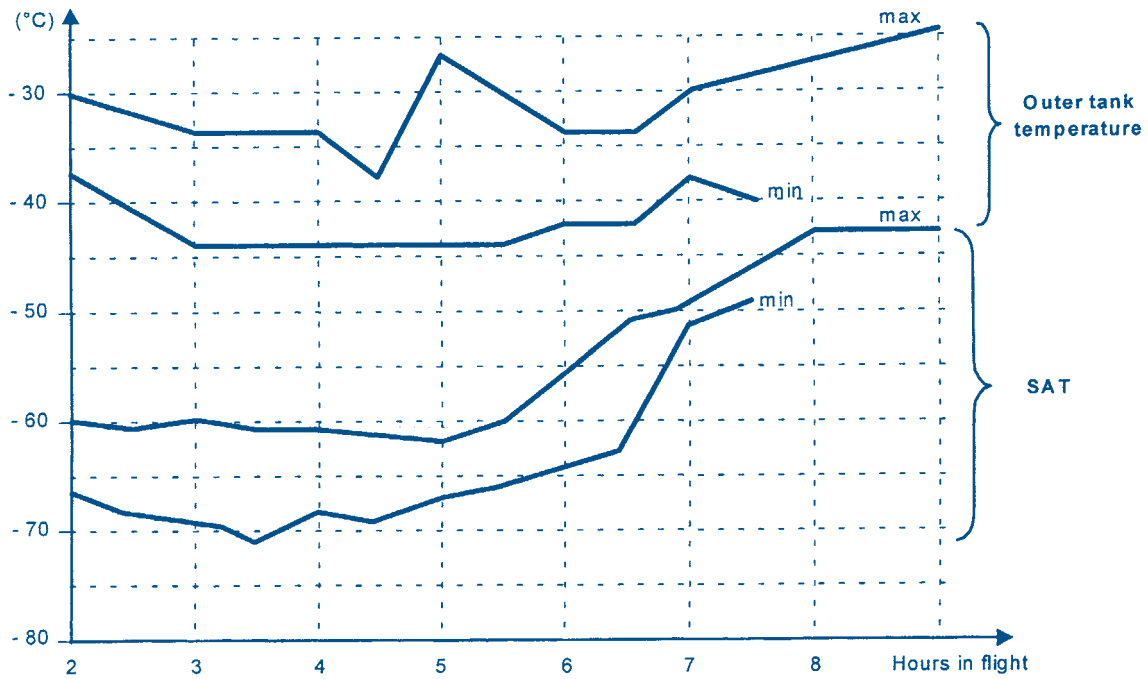

NRT - SVO (FL 314 / 348 / 381 - 13 flights)

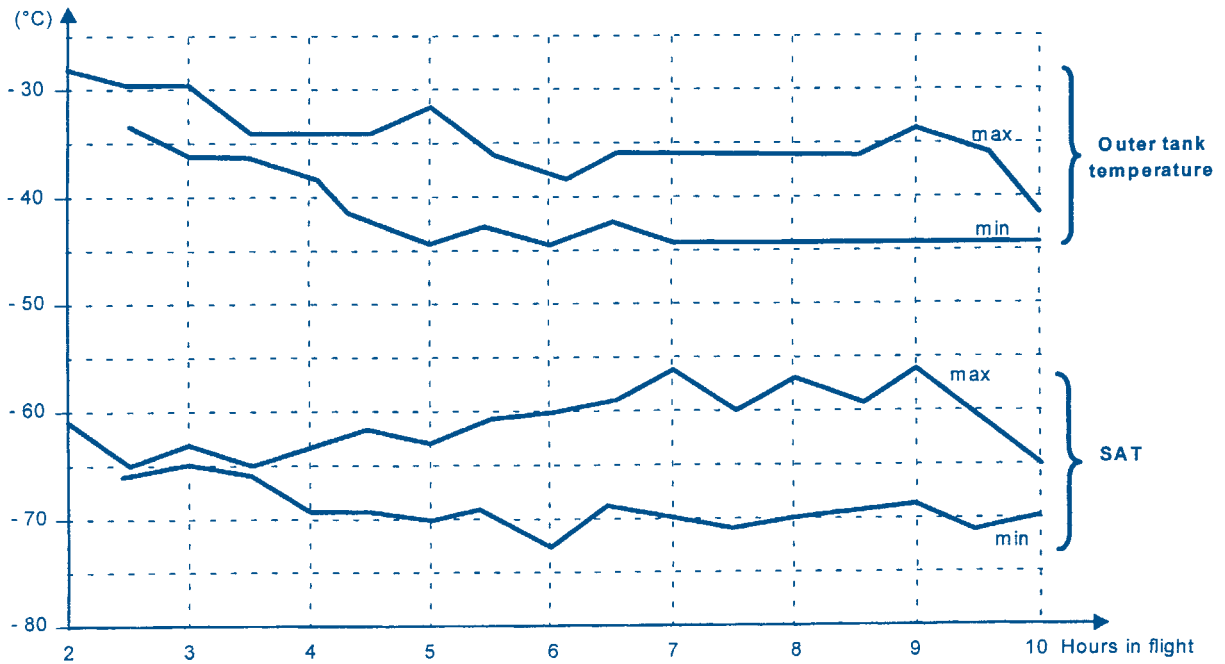

Figure D4 - A310 fuel tank survey - December 91 - February 92

Figure D5 represents traces of a HONG KONG - TOULOUSE A340 flight test, where crew received the Low Temp Advisory (LO) requesting to transfer outer tank fuel if JET A is used.

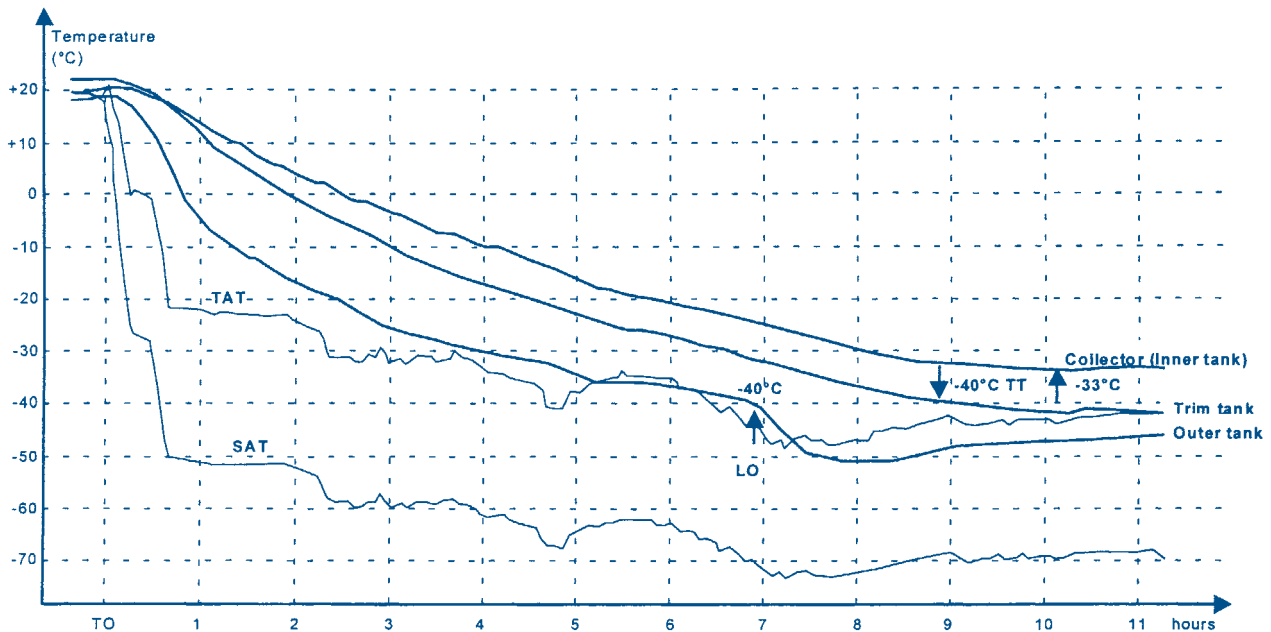

Figure D5

D5 ACTUAL FUEL FREEZING POINT

Being aware of the exact value of the fuel freezing point may bring some benefit when establishing a flight plan or when the crew has to decide whether or not flight conditions have to be altered according to the actual fuel temperature.

D5.1 Fuel freezing point value

As previously mentioned, when known, use of the actual fuel freezing point of the fuel being used may be considered instead of the maximum value authorized by the fuel specification.

This may be of great benefit because suppliers generally produce a fuel with a significantly lower freezing point than that required by the specification.

For example, a survey on JET A fuels made from 1990 up to 1992, showed that the average fuel freezing point of JET A was **-44.5°C** (for -40°C maximum allowed) with minimum values lower than -60°C.

A similar survey conducted by «Phase Technology» (a Canadian company involved in research in cold temperature behavior of petroleum products) between July and September 1998 on JET A fuels in six US major airports showed the following results (all temperatures in °C):

Airport	Mean freezing point	Standard deviation	Max	Min	Average Give-away (*)	Minimum Give-away (*)
Chicago (ORD)	- 43.2	0.43	- 42.4	- 44.7	2.5	1.7
Dallas (DFW)	-42.1	0.79	- 41.1	- 45.9	1.4	0.4
New York (JFK)	- 45.2	0.36	- 44.1	- 46.0	4.5	3.4
Los Angeles (LAX)	-50.9	2.13	- 46.8	- 58.2	10.2	6.1
San Francisco (SFO)	-52.2	1.75	- 48.6	- 56.1	11.5	7.9
Miami (MIA)	- 47.2	3.67	- 41.0	- 53.1	6.5	0.3

(*) Freezing point give-away is a term commonly used to denote the extent by which the actual measured freezing point of an aviation turbine fuel is lower than the specified value (here - 40°C for JET A). The average (minimum) give-away is derived from the mean (maximum) freezing point, but corrected for instrumental uncertainty to a confidence limit of 95%.

Another survey conducted in 1992 in United Kingdom on 1385 batches of JET A1 showed that the mean value was **-51.8°C** (for a specification limit of -47°C - see figure D6).

(Specification limit = - 47°C max, mean = - 51.8°C; standard deviation = 3.74°C)

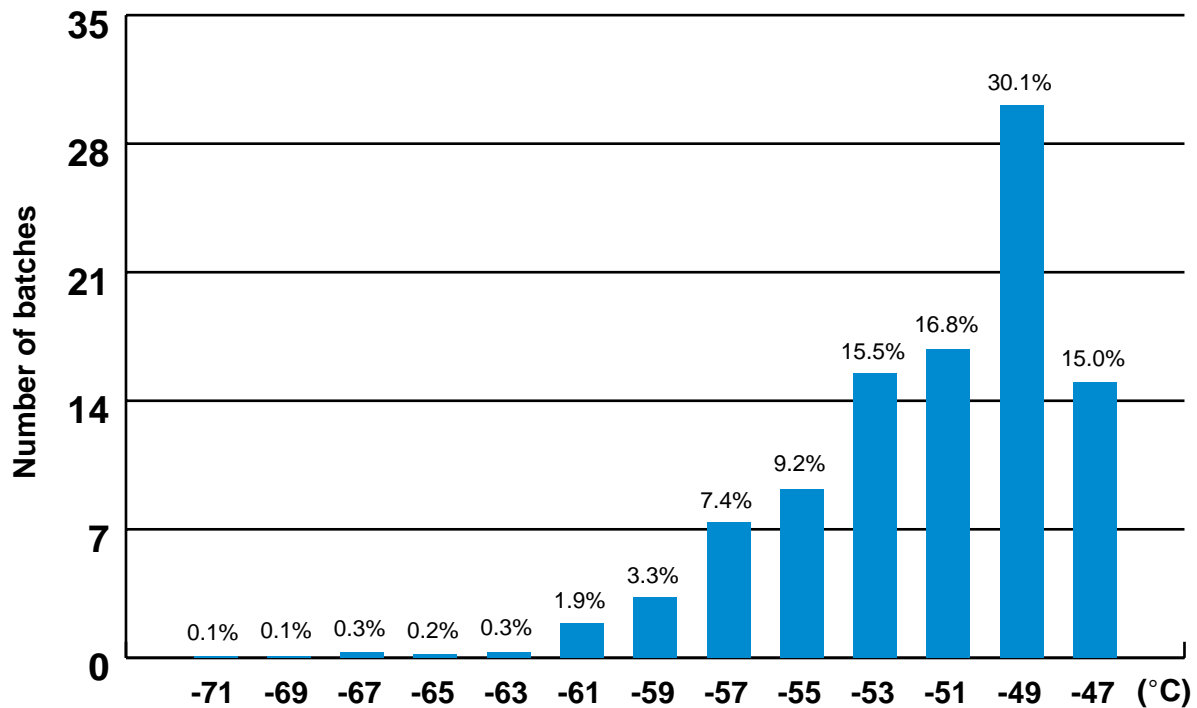

Figure D6 - Freezing point distribution - JET A1

D5.2 Mixing fuels

Based on the research done to-date, it is not really possible to predict the freezing point of mixed fuels, even when the exact freezing points of all the individual components are known.

It is tempting to assume that jet fuels form an ideal solution, since there is a linear relationship between freezing point and blend concentration.

In reality, very few jet fuels behave ideally. Upon blending, freezing point elevation (positive deviation from linearity) and depression (negative deviation) are often observed.

[Figures D7](#) illustrate the results of a study conducted by «Phase Technology». This study focused on 10 finished jet fuels produced by refineries in North America and Europe. The fuel freezing points of these 10 fuels were measured. They were then blended in different combinations and ratios, and the resulting freeze points of these samples were measured.

[Figure D7A](#) is the plot for blends made up of samples called A and H. Both A and H have similar freeze points (-48.8 and -48.2 °C) in the JET A1 range. The concentration of fuel H in the blend is shown on the horizontal axis. At 0% of H, the sample is made up of fuel A only. At the other end of the scale is 100% H. This system is an example of freeze point elevation. The freeze point of all the blends from these two fuels are consistently higher than those expected from ideal solution (dashed line on plot). This graph also shows that all the blends containing more than 28% of fuel H will have freeze points higher than those of A or H individually.

[Figure D7B](#) involves fuels A (JET A1) and F (JP4). This is another example of freeze point elevation. In this case, the freeze point of fuel F (-58.8°C) is much lower than that of fuel A (-48.2°C). The maximum elevation was 2.8°C and it was observed in a blend containing 25% of fuel A and 75% of fuel F.

[Figure D7C](#) shows that fuels B and E display distinct freeze point depression. The maximum depression was 4.6°C. It was noticed that this depression behavior was related to the exceptional solvency power of fuel B.

This study confirmed that mixing jet fuels of different origin gives a final mixture, whereby the freezing point cannot be consistently predicted using a linear relationship.

Therefore, the only reliable way to obtain an accurate freeze point of a mixture of fuels is to make an actual freeze point measurement. Without this, it is not possible to determine the extent or the direction of non-linear solubility.

It would be comforting, if blending always provides freeze point depression. Unfortunately, the reverse behavior, freezing point elevation, appears to be the more prevalent outcome.

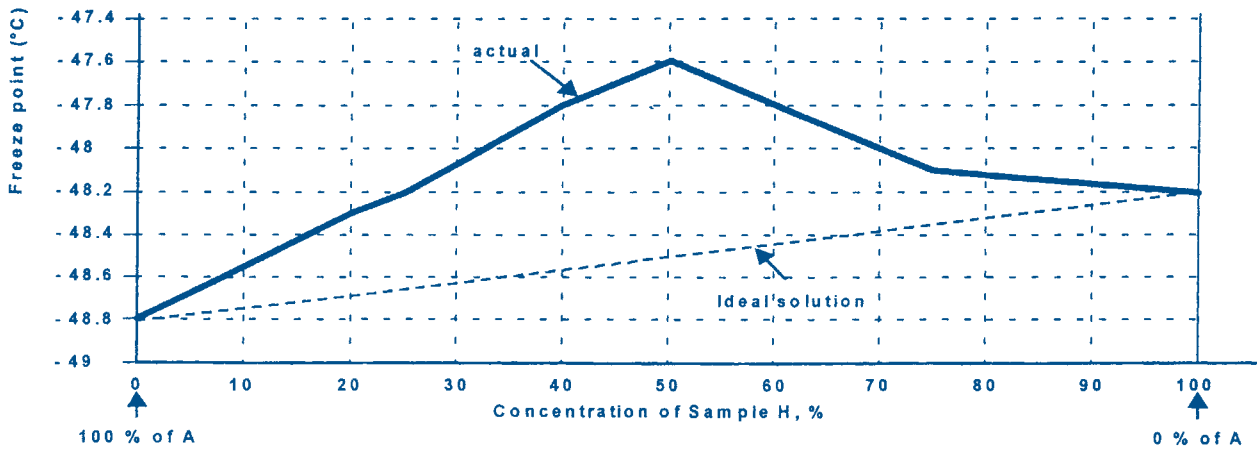

Figure D7A - Freezing point as function of blend concentration for samples A and H

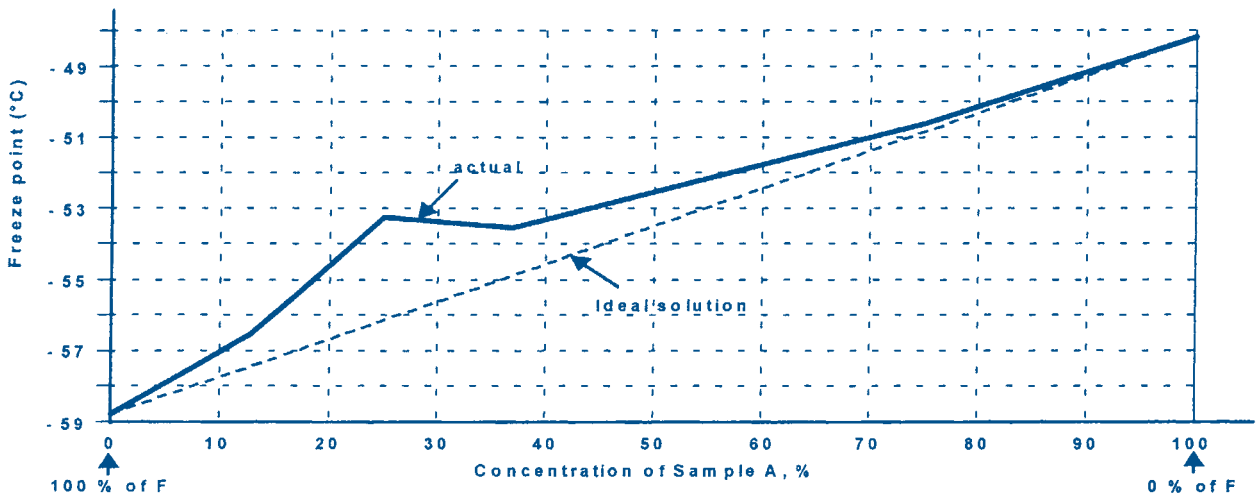

Figure D7B - Freezing point as function of blend concentration for samples A and F

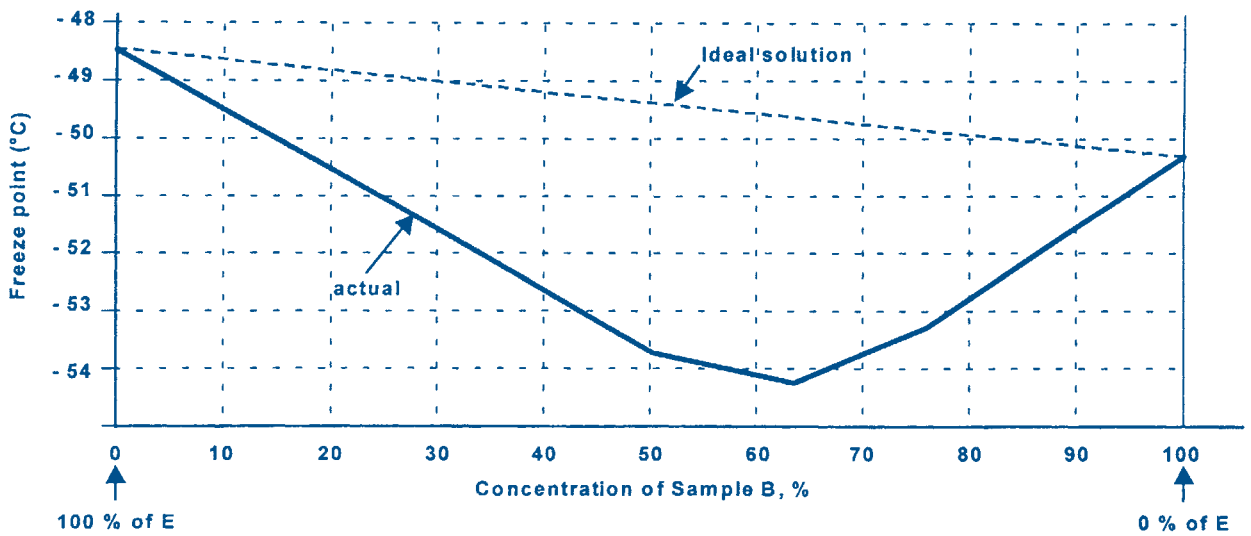

Figure D7C - Freezing point as function of blend concentration for samples B and E

● Practical issues

Notwithstanding what is mentioned above, airlines operating transatlantic or transpacific routes generally have to have their own rules, because they have to continuously cope with the mixture of JET A generally delivered in USA and JET A1 elsewhere.

Some operators have the following pragmatic approach, which may be considered:

- When the mixture contains less than 10% JET A, the fuel is considered as JET A1
- When the mixture contains more than 10% JET A, the fuel is considered as JET A

Mixing all the residual JET A with all the refuel JET A1 to achieve maximum dilution is not considered practical.

To practically achieve the best dilution, all the JET A should be placed in the inner wing tanks as these have the largest volume (by transfer of outer tanks JET A fuel into the inner tanks either during the previous flight or on ground before refueling).

Depending on the aircraft model, inner tanks will receive fuel from the center tank early in the flight, further diluting the JET A.

Placing all the JET A into the inner wing tanks potentially enables a maximum dilution but does not guarantee that the mixture will be homogenous. In reality, due to the compartmental structure of the inner wing tank and the fact that the residual JET A fuel will start at the inboard end of the tank, the concentration of JET A will be greater near the tank's inboard end.

The poor dilution of the JET A in the inner wing tank and its concentration near the inboard end of the tank has a potentially **positive consequence**. This is because the fuel near the inboard end of the inner wing tank tends to be consumed first by the engines. Thus, the concentration of the remaining JET A fuel on board, later in flight, when low fuel temperatures might be encountered in the case of low OATs, will be less than at takeoff. This gives a higher confidence margin that low concentrations of JET A in JET A1 will have a freeze point similar to JET A1 and can thus be treated as JET A1 with respect to the cold fuel alert.

D6 LOW TEMPERATURE BEHAVIOR OF FUEL

The low temperature properties of fuels must be controlled to guarantee adequate system operation. Basic fuel properties, such as freezing point and viscosity, are important factors in fuel pumpability.

Nevertheless, it may be of some interest to have an idea of the expected behavior of the fuel both at its freezing point and below.

D6.1 Pumpability limit

Fuels are a mixture of hydrocarbons. They do not completely solidify at a fixed temperature, as do simple liquids, such as, water. They do not have a single «freezing

point», but a range of temperatures below which they contain a higher and higher proportion of solidified fuel.

For the purpose of routine testing and specification requirements, certain stages in this gradual transition are selected and closely defined (See figure D8):

- The «**freezing point**» is represented as the temperature at which the last wax crystal melts on warming, the fuel having previously been cooled down with stirring. (Different definition, as mentioned before under GOST method)
- The «**cloud point**», which occurs at nearly the same temperature as the «freezing point», is the temperature at which a visible cloudiness appears when fuel is cooled down without stirring.
- The «**pour point**» is the temperature at which the fuel just pours from a standard glass cylinder, the fuel being not stirred.

Tests conducted on certain fuels showed that the pumpability limit ranged from 4°C to 16°C below the freezing point, and from 1°C to 7°C below the pour point, depending on the nature of the fuel.

Thus, the pour point seems to be a better criterion for pumpability limit, but one of its drawbacks is that it is not very precise.

However, test results show that the «pumpability limit» of a fuel is not, in any way, connected with the first appearance of wax crystals.

Therefore, none of the existing laboratory tests can predict the minimum temperature of pumpability.

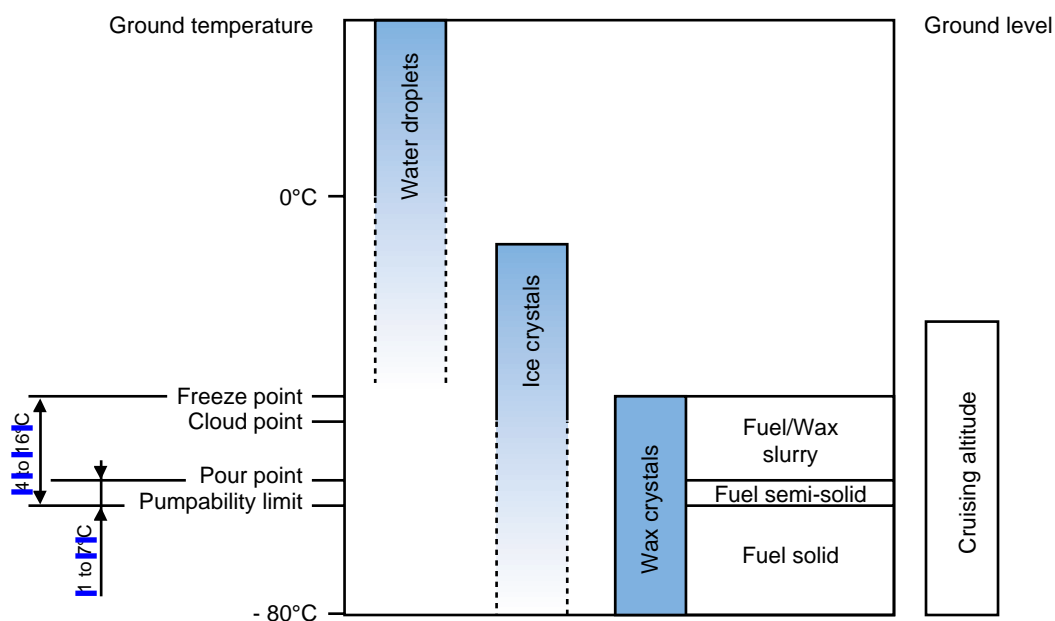

Figure D8 - Low temperature behavior of fuel

Until now, the «freezing point» has been the only test to survive in fuel specifications as a control on low temperature pumpability.

The advantages of using this parameter include the relative ease with which it can be measured for conventional fuels, the reasonable degree of repeatability and reproducibility, and the **margin of safety it ensures**.

However, it is far from clear what relationship exists between the laboratory «freezing point» and the flow behavior of fuel in the aircraft at low temperatures encountered during prolonged flights at high altitude. In the absence of anything more representative, it is obviously better than nothing, but its shortcomings have been acknowledged, and aviation fuel research is developing tests which are specifically designed to correlate with pumpability.

The main interest of such a «pumpability limit» test, in place of the «freezing point» test, is its economic consequences, as it would avoid any waste of potential yield from crude oil.

D6.2 Protection against wax

D6.2.1 Heating the fuel

Heating the whole fuel in the aircraft tanks would prevent wax from forming. Nevertheless, the penalties in weight and the complications make such a system unattractive.

Some aircraft (A319/A320/A321/A340) fitted with a fuel re-circulation system could theoretically take benefit of such a system. But this system is designed to cool the IDG oil, and not to heat the fuel. From a practical standpoint, it is not operative when very low temperatures are encountered.

Increasing the aircraft speed provides a marginal TAT increase (in the order of 0.5 to 1°C for 0.01 M increase) and thus a small fuel temperature increase, at the expense of a significant increase in fuel consumption.

Decreasing altitude generally provides a SAT increase (about 2°C per 1000 ft). Nevertheless, whenever the tropopause is substantially low, decreasing the altitude may not provide the corresponding expected SAT and, thus, TAT increase.

D6.2.2 Thermal insulation of tanks

Weight penalties of thermal insulation of tanks make this system impractical.

Nevertheless, it may be worth noticing that the fuel itself provides a free bonus, if unexpectedly low ambient temperatures are encountered, so that the fuel temperature falls below its pour point.

In such rare cases, because the temperature gradient from the tank surfaces inwards, solidification of fuel begins at the tank surface and thereby provides its own thermal insulation. The thermal conductivity of frozen kerosene is approximately the same as that of rubber, so that, as it grows in thickness, it becomes an increasingly effective barrier to further heat losses through the tank walls.

Figure D9 illustrates the relatively slow rate of solidified fuel growth in a typical tank, assuming a TAT of -65°C and a fuel temperature that has fallen below its pour point of -55°C .

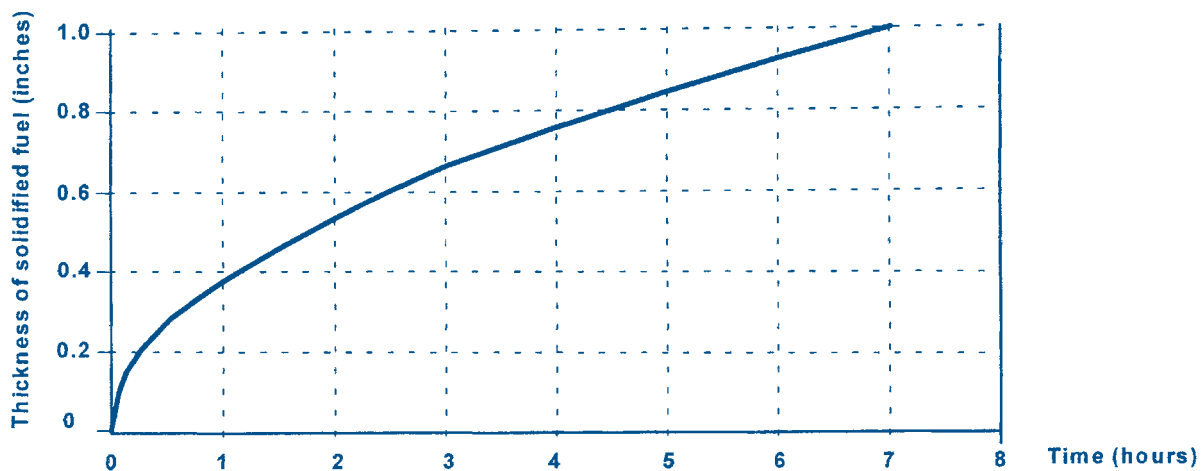

Figure D9 - Growth of solidified fuel layer

The fact that this insulating layer provides a natural protection cannot, of course, be exploited in any way. But, the knowledge that it would be there, working in one's favor, should such conditions ever be met, is reassurance that the result would not be detrimental. Moreover, the solidified fuel would not be lost for that flight, due to temperature increase after descent to warmer conditions.

D6.2.3 Stirring the fuel

If the fuel in the aircraft tanks could be continuously agitated, it would remain fluid to much lower temperatures, owing to the nature of hydrocarbon fuels.

Laboratory tests have shown that booster pump re-circulation, used in conjunction with very slight tank rocking (less than 1 degree at a frequency of 6 cycles per minute), lowered the pumpability temperature limit by 8°C to 11°C .

FUEL FREEZING LIMITATIONS

Please bear in mind:

- The minimum allowed fuel temperature may either be limited by:
 - The **fuel freezing point** to prevent fuel lines and filters from becoming blocked by waxy fuel (variable with the fuel being used) or
 - The **engine fuel heat management** system to prevent ice crystals, contained in the fuel, from blocking the fuel filter (fixed temperature). The latter is often outside the flight envelope and, thus, transparent to the pilot.

- Different fuel types having variable freezing points may be used as mentioned in the FCOM. When the actual freezing point of the fuel being used is unknown, the limitation is given by the minimum fuel specification values. In addition, a margin for the engine is sometimes required.

The resulting limitation may be penalizing under certain temperature conditions especially when JET A is used (maximum freezing point -40°C). In such cases, **knowledge of the actual freezing point of the fuel being used generally provides a large operational benefit** as surveys have shown a significant give-away.

- Although the **fuel freezing limitation** should not be deliberately exceeded, it should be known that it **ensures a significant safety margin**.

- When mixing fuel types, operators should set their own rules with regard to the resulting freezing point, as it is not really possible to predict it.

When a mixture of JET A/JETA1 contains less than 10% of JETA, considering the whole fuel as JETA1, with respect to the freezing point, is considered to be a pragmatic approach by Airbus Industrie when associated with recommended fuel transfer.

E. LOW TEMPERATURE EFFECT ON ALTIMETER INDICATION



E1 GENERAL

The pressure (barometric) altimeters installed on the aircraft are calibrated to indicate true altitude under International Standard Atmosphere (ISA) conditions.

This means that the pressure altimeter indicates the elevation above the pressure reference by following the standard atmospheric profile.

Any deviation from ISA will, therefore, result in an incorrect reading, whereby the indicated altitude differs from the true altitude.

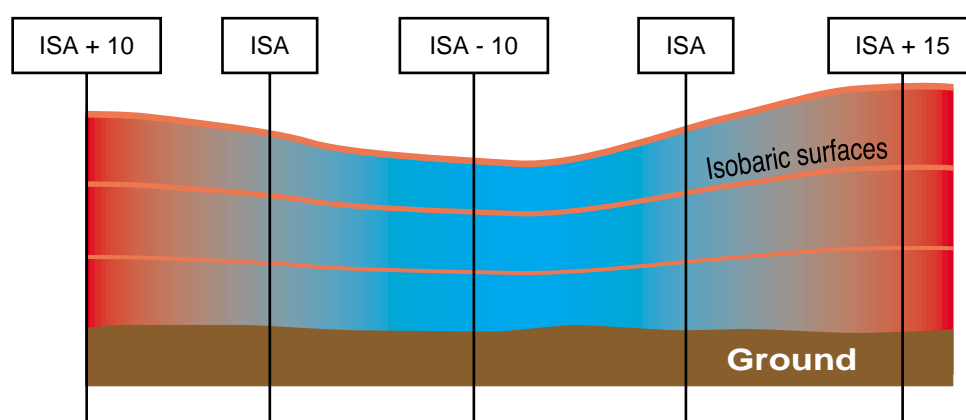

Figure E1

Temperature greatly influences the isobaric surface spacing which affects altimeter indications.

When the temperature is lower than ISA, the true altitude of the aircraft will be lower than the figure indicated by the altimeter.

Specifically, this occurs in cold weather conditions, where the temperature may be considerably lower than the temperature of the standard atmosphere and may lead to a significant altimeter error.

A low temperature may decrease terrain clearance and may create a potential terrain clearance hazard. It may also be the origin of an altitude/position error.

E2 CORRECTIONS

Various methods are available to correct indicated altitude, when the temperature is lower than ISA.

In all cases, the correction has to be applied on the height above the elevation of the altimeter setting source. The altimeter setting source is generally the atmosphere pressure at an airport, and the correction on the height above the airport has to be applied on the indicated altitude. The same correction value is applied when flying at either QFE or at QNH.

The choice of a method depends on of the amount of precision needed for the correction.

E2.1 Low altitude temperature corrections

- **Approximate correction**

Increase obstacle elevation by 4% per 10°C below ISA of the height above the elevation of the altimeter setting source, **or**,
decrease aircraft indicated altitude by 4% per 10°C below ISA of the height above the elevation of the altimeter setting source.

This method is generally used to adjust minimum safe altitudes and may be applied for all altimeters setting source altitudes for temperatures above -15°C.

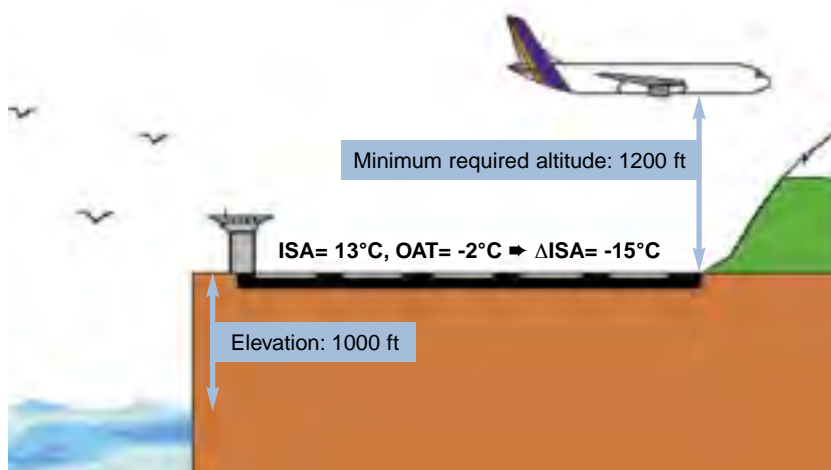

Figure E2

Example:

Let's assume an airport elevation of 1000 ft. The airport elevation is the same as altimeter setting source altitudes elevation = 1000 ft.
The ISA temperature at 1000 ft is 13°C.

Let's now assume that the Actual Outside Air Temperature (OAT) is -2°C.
The ISA deviation is then, $\Delta ISA = (13^\circ C) - (-2^\circ C) = -15^\circ C$.

It is assumed that the minimum required actual altitude to clear the obstacle is 1200 ft.

In order to account for the ISA deviation, the terrain/obstacle elevation has to be increased by: $1200 \times 0.04 \times 15/10 = 72 \text{ ft}$

In other words, the altimeter must read 1272 ft in order to have an actual height of 1200 ft.

● **Tabulated corrections**

ICAO publishes the following tables in the «PANS-OPS Flight Procedures» manual. They are based on an airport elevation of 2000 ft; however, they may be used operationally at any airport.

Altitude correction (m)

Aerodrome temp °C	Height above the elevation of the altimeter setting source (m)													
	60	90	120	150	180	219	240	270	300	450	600	900	1200	1500
0°C	0	6	6	6	12	12	12	12	12	18	24	40	54	67
-10°C	6	6	12	12	12	18	24	24	24	36	48	79	103	128
-20°C	6	12	12	18	24	24	30	36	36	54	72	115	150	189
-30°C	12	12	18	24	30	36	40	40	48	72	97	150	201	250
-40°C	12	18	24	30	36	40	48	54	60	90	122	189	250	311
-50°C	12	24	30	36	40	54	60	67	72	110	146	225	299	372

Altitude correction (ft)

Aerodrome temp °C	Height above the elevation of the altimeter setting source (ft)													
	200	300	400	500	600	700	800	900	1000	1500	2000	3000	4000	5000
0°C	0	20	20	20	20	40	40	40	40	60	80	140	180	220
-10°C	20	20	40	40	40	60	80	80	80	120	160	260	340	420
-20°C	20	40	40	60	80	80	100	120	120	180	240	380	500	620
-30°C	40	60	80	100	120	130	150	170	190	280	380	570	760	950
-40°C	40	60	80	100	120	140	160	180	200	300	400	620	820	1020
-50°C	40	80	100	120	140	180	200	220	240	360	480	740	980	1220

Example:

Solving the previous example with this method:

- Enter the table with 1200 ft. To avoid an interpolation, use 1500 ft.
- Enter the table with -2°C. To avoid an interpolation, use -10°C.
- Read that the correction on the altimeter indication must be 120 ft.

Altitude correction (ft)

Aerodrome temp °C	Height above the elevation of the altimeter setting source (ft)													
	200	300	400	500	600	700	800	900	1000	1500	2000	3000	4000	5000
0°C	0	20	20	20	20	40	40	40	40	60	80	140	180	220
-10°C	20	20	40	40	40	60	80	80	80	120	160	260	340	420
-20°C	20	40	40	60	80	80	100	120	120	180	240	380	500	620
-30°C	40	60	80	100	120	130	150	170	190	280	380	570	760	950
-40°C	40	60	80	100	120	140	160	180	200	300	400	620	820	1020
-50°C	40	80	100	120	140	180	200	220	240	360	480	740	980	1220

● **Formula**

Low altitude correction:

$$\Delta Z = [(QNHalt - Zt) * \Delta T] / [288.15 - (QNHalt * L / 2)]$$

- ΔT = difference between the airport temperature and ISA temperature of the airport ($\Delta ISA^\circ C$).
- Zt = airport altitude.
- $QNHalt$ = aircraft indicated altitude above sea level.
- L = temperature gradient: $0.0065^\circ C$ per m or $0.00198^\circ C$ per ft in function of the unit chosen for Zt and $QNHalt$.

The following table is illustrated in the FCOM, and is based on the above-noted formula.

Low altitude correction table:

QNH ALTITUDE MINUS TERRAIN ELEVATION (ft) ➔		ΔZ CORRECTION (ft)					
		500	1000	1500	2000	2500	3000
ΔISA	-10 °C	-17	-34	-51	-68	-85	-102
	-20 °C	-35	-70	-105	-140	-175	-210
	-30 °C	-52	-104	-156	-208	-260	-312
	-40 °C	-70	-140	-210	-280	-350	-420

TRUE ALTITUDE = QNH ALTITUDE + ΔZ
 Note: A constant ΔISA from ground to airplane level has been assumed

Example:

Solving the previous example with this table:

- Enter the table with 1200 ft. To avoid an interpolation, use 1500 ft.
- Enter the table with $\Delta ISA = -15^\circ C$. To avoid an interpolation, use $-20^\circ C$.
- Read that the correction on the altimeter indication must be 105 ft.

QNH ALTITUDE MINUS TERRAIN ELEVATION (ft) ➔		ΔZ CORRECTION (ft)					
		500	1000	1500	2000	2500	3000
ΔISA	-10 °C	-17	-34	-51	-68	-85	-102
	-20 °C	-35	-70	-105	-140	-175	-210
	-30 °C	-52	-104	-156	-208	-260	-312
	-40 °C	-70	-140	-210	-280	-350	-420

TRUE ALTITUDE = QNH ALTITUDE + ΔZ
 Note: A constant ΔISA from ground to airplane level has been assumed

● **Application of Low altitude corrections.**

Corrections on an indicated altitude have to be applied on the published minimum altitude except when the criteria used to determine minimum flight altitudes are already published and take into account low temperature influences (Mentioned on AIP).

On approach, at least the following published altitudes must be increased in low OAT conditions:

- MSA,
- FAF altitude,
- Step-down altitude(s) and MDA(H) during a non-precision approach,
- OM altitude during an ILS approach,
- Waypoint crossing altitudes during a GPS approach flown with vertical navigation.

As it is not allowed to modify the altitude constraints of a non-precision approach, a minimum OAT to fly the approach with the «FINAL APPR» FMGC mode must be established.

For OAT lower than this minimum, selected vertical navigation must be used.

Remark:

The determination of the lowest useable flight levels by Air Traffic Control units within controlled airspace does not relieve the pilot-in-command from the responsibility of ensuring that adequate terrain clearance will exist, except when an IFR flight is being vectored by radar.

E2.2 High altitude temperature corrections (En-route)

Formula: $IA = TA \times T^{\circ std} / T^{\circ}$

IA = Indicated Altitude
TA = True Altitude
T°std = Temperature standard (°K)
T° = Actual temperature (°K)

Example:

Let's assume that the actual altitude is 16500 ft and actual temperature is -48°C.
T°std: temperature standard at 16500 ft = -18°C = 255°K
T°: actual temperature at 16500ft = -48°C = 225°K (ISA -30°C)

$$IA = 16500 \times 255/225 = 18700 \text{ ft}$$

The following chart is illustrated in the FCOM, and is based on the above-noted formula.

ALTITUDE TEMPERATURE CORRECTION

FOR HIGH ALTITUDE USE

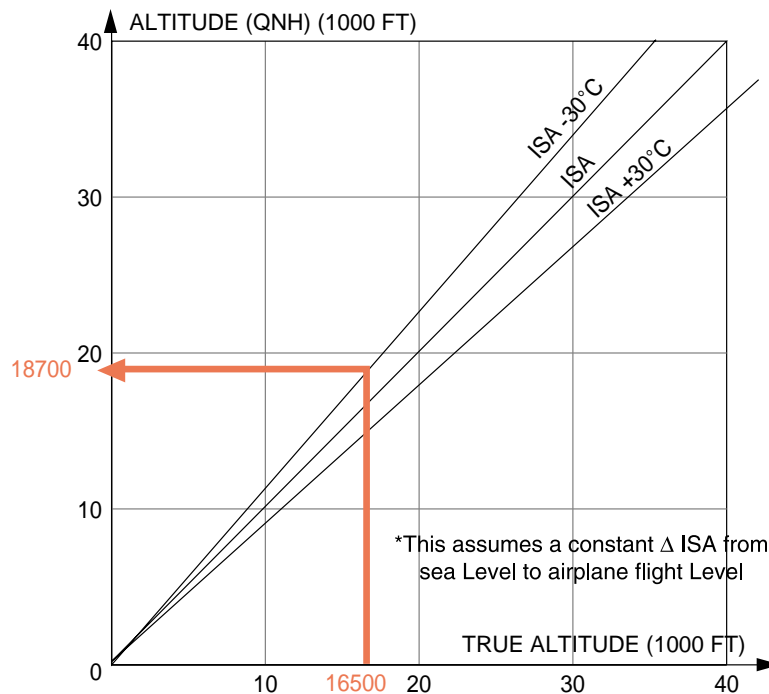

Figure E3

This formula doesn't take into account the elevation of the altimeter setting source. It has to be used en route and must not be used to adjust low altitude.

● Application of high altitude temperature corrections.

In theory, this correction applies to the air column between ground and aircraft. When flying above mountain areas, the use of this correction gives a conservative margin. Special care should be exercised, in case of depressurization failure or engine failure, to avoid flying closer to the obstacles.

E3 TAKEOFF CHARTS

E3.1 Acceleration altitude

The Acceleration altitude specified on the Airbus takeoff chart is the (minimum) Indicated Altitude at which the pilot must perform the acceleration altitude, in case of an engine-out during takeoff. It ensures obstacle clearance.

The specified acceleration altitude is the highest of all the acceleration altitudes, after having applied temperature correction. It takes into account the lowest temperature of the table. In other words, it considers the maximum ISA deviation of the table.

Consequently, provided OAT is greater than the lowest temperature indicated on the chart, it is not necessary to adjust the published minimum acceleration height for the effect of low temperature.

On the contrary, **when OAT is lower than the lowest temperature of the takeoff chart, the published acceleration altitude has to be increased** by the value found in the FCOM's Low Altitude Temperature Correction Table.

Remark: Low Altitude Temperature Correction Table has to be entered with ΔISA . Replace ΔISA by the difference between the OAT and the lowest temperature of the table.

Let's illustrate this by an example.

Step 1:

Consider the following takeoff chart (You shall zoom the figure below to display it).

: A340313 - JAA		: CFM56-5C4 engines		: Airport name		: 15R		: 16.0.1 07-DEC-99	
: QNH 1013.25 HPA		: Elevation 1000 FT		: TORA 3000 M		: DRY		: AA313B02 *V 9	
: Air cond. AC OFF		: ISA temp 13 C		: TODA 3000 M		: CONF 2			
: Anti-icing AI OFF		: rwy slope 0.00%		: ASDA 3000 M		: 1 obstacle		: NO DERATE	
: Do not use for operations									
: OAT		: TAILWIND		: WIND		: HEADWIND		: HEADWIND	
: C		: -10 KT		: 0 KT		: 10 KT		: 20 KT	
: 0		: 183.7 4/4		: 195.2 4/4		: 199.3 4/4		: 203.4 4/4	
		: 128/29/44		: 128/29/43		: 128/30/44		: 128/31/45	
: 5		: 183.2 4/4		: 194.7 4/4		: 198.8 4/4		: 202.9 4/4	
		: 128/29/44		: 128/29/43		: 128/29/43		: 128/31/45	
: 10		: 182.7 4/4		: 194.2 4/4		: 198.3 4/4		: 202.4 4/4	
		: 128/29/44		: 128/29/43		: 128/29/43		: 128/31/45	
: 15		: 182.2 4/4		: 193.7 4/4		: 197.7 4/4		: 201.8 4/4	
		: 128/29/44		: 128/29/43		: 128/29/43		: 128/30/44	
: 20		: 181.7 4/4		: 193.2 4/4		: 197.2 4/4		: 201.2 4/4	
		: 128/29/44		: 128/29/43		: 128/29/43		: 128/30/43	
: 25		: 181.3 4/4		: 192.7 4/4		: 196.7 4/4		: 200.7 4/4	
		: 128/29/44		: 128/29/43		: 128/29/43		: 128/30/43	
: 30		: 177.9 4/4		: 189.3 4/4		: 193.3 4/4		: 197.2 4/4	
		: 128/29/43		: 128/29/42		: 128/29/42		: 128/29/42	
: 40		: 162.8 4/4		: 173.5 4/4		: 177.3 4/4		: 181.2 4/4	
		: 128/29/42		: 128/29/41		: 128/29/41		: 128/29/41	
: 50		: 144.7 4/4		: 153.9 4/4		: 157.4 4/4		: 160.9 4/4	
		: 128/29/40		: 127/29/39		: 127/29/39		: 127/29/39	
: 53		: 138.3 4/4		: 147.2 4/4		: 150.8 4/4		: 154.4 4/4	
		: 128/29/39		: 127/29/39		: 127/29/39		: 127/29/39	
: LABEL FOR INFLUENCE		: MTOW(1000 KG) codes		: VMC		: Tref (OAT) = 28 C		: Min acc height 1444 FT	
: DW (1000 KG) DTFLX		: V1min/VR/V2 (kt)		: LIMITATION		: Tmax (OAT) = 53 C		: Max acc height 8145 FT	
: DV1-DVR-DV2 (KT)								: alt 2444 FT	
: (TVMC OAT C)		: LIMITATION CODES						: alt 9145 FT	
: DW (1000 KG) DTFLX		: 1=1st segment 2=2nd segment 3=runway length 4=obstacles						: Min V1/VR/V2 = 128/29/35	
: DV1-DVR-DV2 (KT)		: 5=tire speed 6=brake energy 7=max weight 8=final take-off 9=VMU						: CHECK VMU LIMITATION	
								: Correct. V1/VR/V2 = 0.2 KT/1000 KG	

Step2:

Consider the lowest chart temperature: 0°C

Consider the associated minimum acceleration height: 1444 ft

Step3:

Let's assume that OAT is -20°C

The temperature deviation between 0°C and -20°C is 20°C.

Step4:

Enter the correction table with the acceleration height (1444 ft rounded to 1500ft), and -20°C.

QNH ALTITUDE MINUS TERRAIN ELEVATION (ft) ➔		ΔZ CORRECTION (ft)					
		500	1000	1500	2000	2500	3000
ΔISA	-10 °C	-17	-34	-51	-68	-85	-102
	-20 °C	-35	-70	-105	-140	-175	-210
	-30 °C	-52	-104	-156	-208	-260	-312
	-40 °C	-70	-140	-210	-280	-350	-420

TRUE ALTITUDE = QNH ALTITUDE + ΔZ
 Note: A constant ΔISA from ground to airplane level has been assumed

Read the correction: 105 ft. The minimum acceleration height should be increased by 105ft. This means that minimum acceleration height is 1549ft (1444 ft + 105 ft)

Remark:

Let's compare with a takeoff chart including -20°C. In such a case, a correction is useless. The minimum acceleration altitude has been increased (1562ft) to account for the deviation. (You shall zoom the figure below to display it).

A340313 - JAA		CFM56-5C4 engines		Airport name		15R		16.0.1 07-DEC-99	
QNH 1013.25 HPA		Elevation 1000 FT		TORA 3000 M		DRY		AA313B02 *V 9	
Air cond. AC OFF		Isa temp 13 C		TODA 3000 M		CONF 2			
Anti-icing AI OFF		rwy slope 0.00%		ASDA 3000 M		1 obstacle		NO DERATE	
Do not use for operations									
OAT	TAILWIND	WIND		HEADWIND		HEADWIND			
C	-10 KT	0 KT		10 KT		20 KT			
-20	185.2 4/4 128/29/45	196.6 4/4 128/29/44		200.9 4/4 128/30/45		205.1 4/4 128/32/46			
-15	184.9 4/4 128/29/45	196.3 4/4 128/29/44		200.5 4/4 128/30/45		204.7 4/4 128/31/46			
-10	184.5 4/4 128/29/44	196.0 4/4 128/29/43		200.2 4/4 128/30/44		204.3 4/4 128/31/45			
-5	184.2 4/4 128/29/44	195.6 4/4 128/29/43		199.7 4/4 128/30/44		203.9 4/4 128/31/45			
0	183.7 4/4 128/29/44	195.2 4/4 128/29/43		199.3 4/4 128/30/44		203.4 4/4 128/31/45			
5	183.2 4/4 128/29/44	194.7 4/4 128/29/43		198.8 4/4 128/29/43		202.9 4/4 128/31/45			
10	182.7 4/4 128/29/44	194.2 4/4 128/29/43		198.3 4/4 128/29/43		202.4 4/4 128/31/45			
15	182.2 4/4 128/29/44	193.7 4/4 128/29/43		197.7 4/4 128/29/43		201.8 4/4 128/30/44			
20	181.7 4/4 128/29/44	193.2 4/4 128/29/43		197.2 4/4 128/29/43		201.2 4/4 128/30/43			
25	181.3 4/4 128/29/44	192.7 4/4 128/29/43		196.7 4/4 128/29/43		200.7 4/4 128/30/43			
30	177.9 4/4 128/29/43	189.3 4/4 128/29/42		193.3 4/4 128/29/42		197.2 4/4 128/29/42			
40	162.8 4/4 128/29/42	173.5 4/4 128/29/41		77.3 4/4 128/29/41		181.2 4/4 128/29/41			
50	144.7 4/4 128/29/40	153.9 4/4 127/29/39		157.4 4/4 127/29/39		160.9 4/4 127/29/39			
53	138.3 4/4 128/29/39	147.2 4/4 127/29/39		150.8 4/4 127/29/39		154.4 4/4 127/29/39			
: LABEL FOR INFLUENCE: MTOW(1000 KG) codes		: VMC		: Tref (OAT) = 28 C		: Min acc height 1562 FT		: Min QNH alt 2562 FT	
: DW (1000 KG) DTFLEX : V1min/VR/V2 (kt)		: LIMITATION: Tmax (OAT) = 53 C				: Max acc height 8145 FT		: Max QNH alt 9145 FT	
: DV1-DVR-DV2 (KT)									
: (TVMC OAT C) : LIMITATION CODES:									
: DW (1000 KG) DTFLEX: 1=1st segment 2=2nd segment		3=runway length 4=obstacles		: CHECK VMU LIMITATION		: Min V1/VR/V2 = 128/29/35			
: DV1-DVR-DV2 (KT) : 5=tire speed 6=brake energy		7=max weight 8=final take-off 9=VMU		: Correct. V1/VR/V2		= 0.2 KT/1000 KG			

E3.2 Takeoff margins

When the temperature is very low, the difference between OAT and flex temperature may be very large. In this case, the following question may be asked:
 «Is the takeoff chart data still useable, and is there still a sufficient margin between the terrain/obstacles and the takeoff flight path?»

The answer is «YES».

The reason is that:

- For a given selected flex temperature, the actual OAT does not affect the engine thrust. Therefore, the climb gradient is not modified.
- For the same IAS, the ground speed is lower when OAT is lower and, consequently
 - The margins with tire speed and brake energy limitations are increased,
 - The TOD and the ASD are decreased.

This signifies that a reduction in ground speed allows a higher margin above terrain/obstacle or a longer decision time than that defined by the regulations.

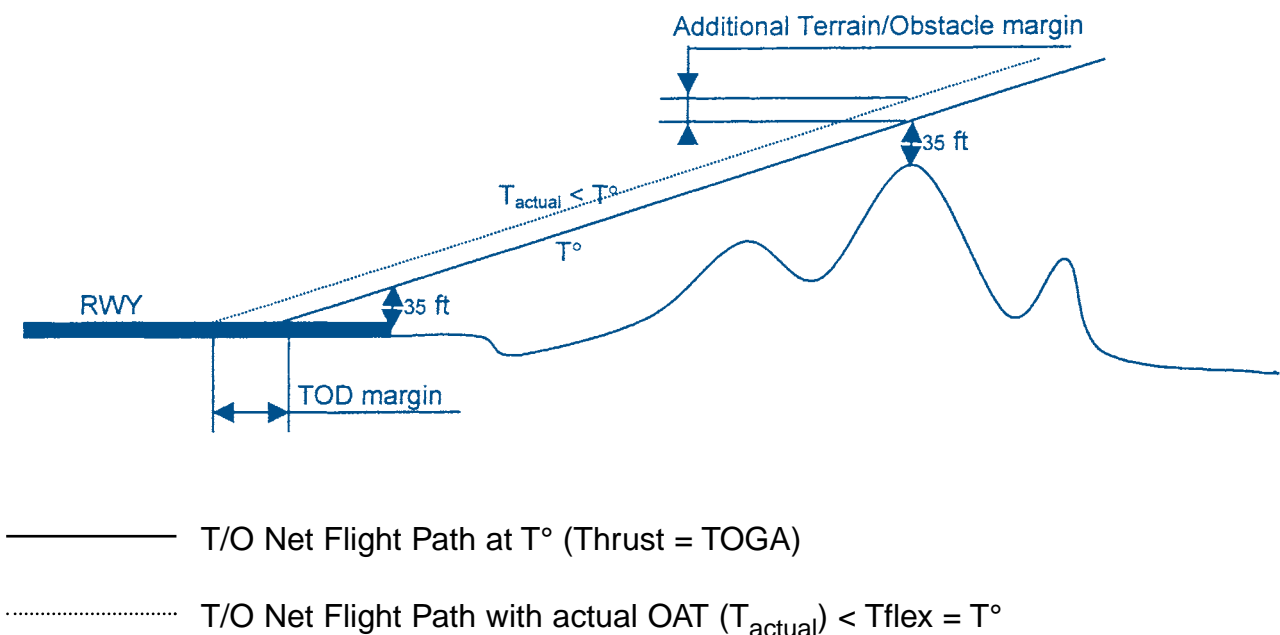

Figure E4

LOW TEMPERATURE EFFECT ON ALTIMETRY

Please bear in mind:

- Temperature below ISA:
 - ➔ Aircraft **true altitude below indicated altitude**

- Very low temperature may :
 - ➔ Create a potential terrain hazard
 - ➔ Be the origin of an altitude/position error.

- Corrections have to be applied on the height above the elevation of the altimeter setting source by:
 - ➔ Increasing the height of the obstacles, or
 - ➔ Decreasing the aircraft indicated altitude/height.

- Minimum OAT should be established and specified for using approach and takeoff procedures if FINAL APPR mode (V-NAV in approach) use is intended.

- When OAT is below the minimum temperature indicated on a takeoff chart, the minimum acceleration height/altitude must be increased.

 **AIRBUS INDUSTRIE**

© Airbus Industrie 2000
All rights reserved.

The statements made herein do not constitute an offer. They are based on the assumptions shown and are expressed in good faith. Where the supporting grounds for these statements are not shown the Company will be pleased to explain the basis thereof.

**Customer Services Marketing
31707 Blagnac Cedex France
Telephone +33 (0) 5 61 93 33 33**